



Pendulum™ Wheel Washer

Sonny's patented Pendulum tracks each wheel, following it with a high-pressure wash for a full five feet to focus on cleaning wheels and tires at high chain speeds without prepping.

Features

- Pendulum action that raises and lowers the spinning Zero-Degree Plus Nozzle manifold to cover all wheel heights.
- Simple mechanical design requires little maintenance and automatically adjusts to any conveyor speed.
- Increased contact time delivers necessary impact to loosen even the most difficult brake dust and road grime.

Specifications

Footprint Length	107in
Footprint Width	152in
Unit Height	136in
Vehicle Clearance	90in
Water Inlet	1in
Water/Pendulum	Max. 20GPM @650-800PSI
Air	@40PSI

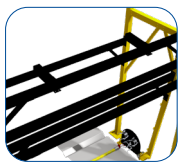

Counterweights and simple mechanical design for easy maintenance and reliability.

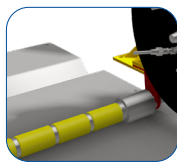

Pendulum arm drops into groove stainless steel plate allowing wheel to pass before resetting.

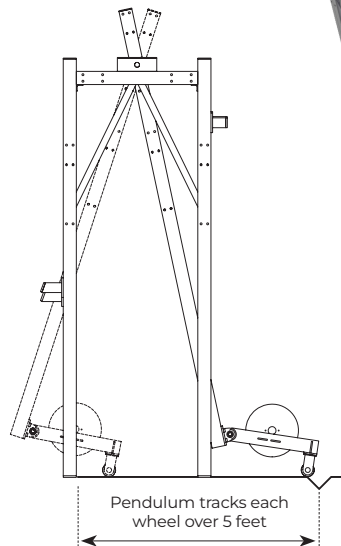

Pendulum with Spinner Plus. Shown with Optional Powder Coating

CUSTOM COLOR POWDER COATING OPTION
Contact a Sonny's Sales Representative for details.



Call 1-800-327-8723 to Order

Join Sonny's
OneWash
and Save

Get Exclusive Member Benefits!
SonnyDirect.com/onewash

Pendulum with Spinner or Spinner Plus

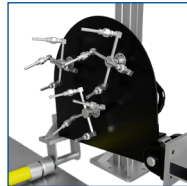
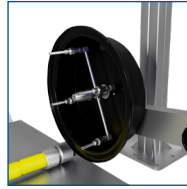

Pendulum Spinner

Sonny's Pendulum Spinner features four spinners and 15 Zero-Degree Plus Nozzles per side. They deliver the necessary impact to loosen difficult brake dust and other road grime for a perfectly clean wheel every time.

Pendulum Spinner Plus

Sonny's Pendulum Plus features three spinners and 12 of our Zero-Degree Plus nozzles per side, increasing coverage to thoroughly clean every wheel – from the largest truck to most intricate custom rim.

Description	Nozzles*	Price
Pendulum Spinner	(8) Zero-Degree Plus Nozzles, (2) 15° #04 Fan Center Nozzles	\$24,094.00
Pendulum Spinner Plus	(24) Zero-Degree Plus Nozzles	\$28,591.00

Material ID: PENDULUM

*Specify 1GPM, 2GPM or 3GPM nozzles when ordering

Pendulum Combo Foundation Frame Attachment Options



Octopus Mirror Blaster

Wider spray pattern with nine nozzles per side completely flushes mirror housings. Features Pendulum Arm Mounting with Driver and Passenger Side Manifolds.

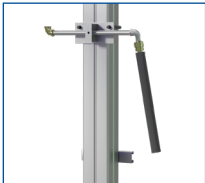

Mirror Blaster

Conserves rinse water and blasts detergent from mirrors. Features Pendulum Arm Mounting with Driver and Passenger Side Manifolds.



Rainbar Mirror Rinse

Completely removes detergent residue resulting in better drying and foam free mirrors. Features Pendulum Arm Mounting with Driver and Passenger Side Manifolds.

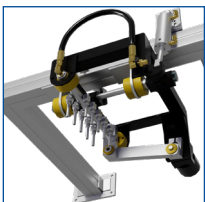

OMNI™ Single and Dual Manifold Top Attachments

Increased high pressure wash coverage without increasing tunnel length. System Includes: All Nozzles and Air Kits.

Description	Mounting Options	Price
Octopus Mirror Blaster	Pendulum Frame, DS & PS Manifolds	\$2,327.00

Material ID: MIRROR_RINSE

Description	Mounting Options	Price
Mirror Blaster	Pendulum Frame, DS & PS Manifolds	\$1,380.00

Material ID: MIRROR_RINSE

Description	Mounting Options	Price
Rainbar Mirror Blaster	Pendulum Frame, DS & PS Manifolds	\$813.00

Material ID: MIRROR_RINSE

Description	Mounting Options	Hydraulic	Electric	
OMNI™ Top Blaster	Entrance Side	Single Manifold (10) Zero Degree Plus Nozzles	\$7,213.00	\$8,755.00
		Dual Manifold (20) Zero Degree Plus Nozzles	\$10,412.00	\$11,711.00

Material ID: OMNI_BKT_TOP