

VACUUM IQ

INTELLIGENT VACUUM CONTROLLER

QUICK START GUIDE

DELTA Variable Frequency Drive
40HP X 1 460V

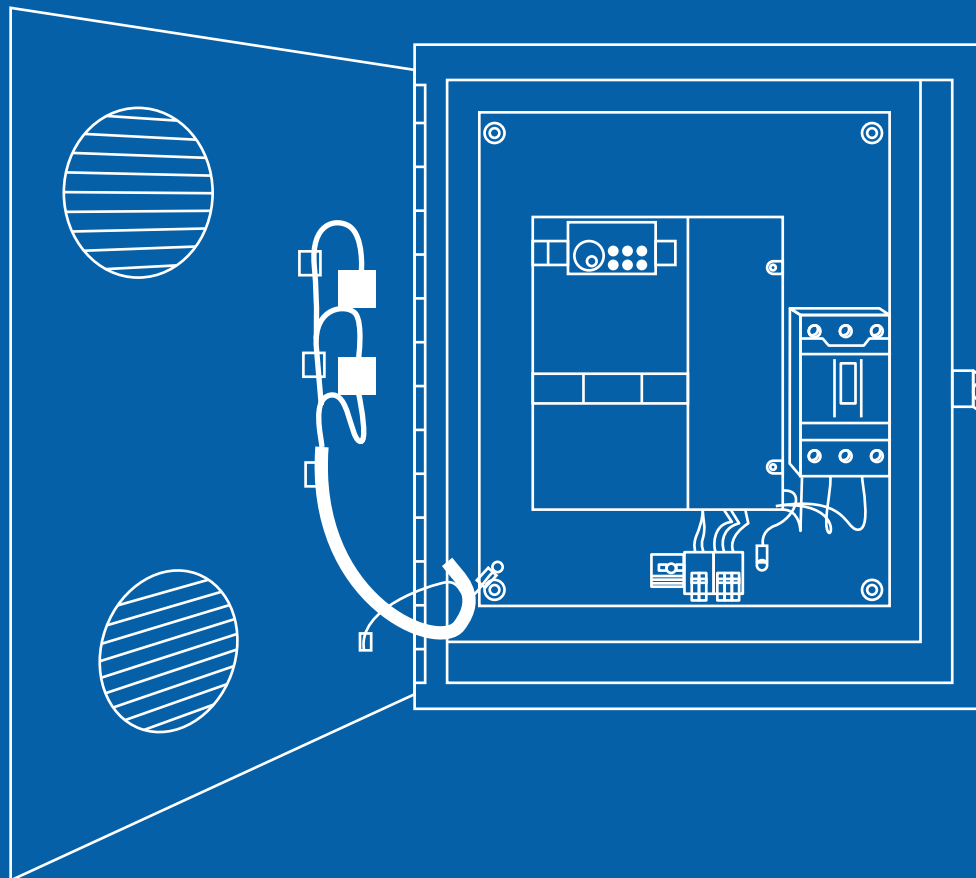

Sonny's CarWash
Vacuums
by AUTOMAC

425-11082-DELTA

QUICK START GUIDE FOR VACUUM IQ USING THE C2000 SERIES VFD

OVERVIEW

This guide is to assist in the start up of the C2000 series variable frequency drives.

In **Chapter 1:**

The installation of the Variable Frequency Drive will be covered.

In **Chapter 2:**

The input power to the package, vacuum motor and pressure transducer connections will be shown.

In **Chapter 3:**

The operation of VFD display will be covered.

In **Chapter 4:**

Will deal with electrical drawings for different package configuration (multiple motors).

In **Chapter 5:**

Includes factory VFD parameters for different package configurations.

Please take time to review this Guide before proceeding with the installation and testing.



DANGER!

LETHAL VOLTAGES ARE PRESENT Before applying power to the variable frequency drive, ensure that all protective covers are on and all wiring connections are secure. After the power has been turned OFF, wait at least **5 minutes** or until the display indicator ***extinguishes completely*** before touching any wiring, circuit boards or components.

CHAPTER 1 - INSTALLATION AND WIRING

Installation

- Please review and verify that the inverter was received free of damage and is the correct size for the motor being used.
- To ensure personnel safety and to avoid equipment damage, follow standard precautions and the installation procedures for mounting, wiring, and operating environment.

Wiring

- Be sure to follow all applicable codes in make electrical connections to the motor and input power terminals, as well as the control wiring.
- Transducer wiring should be run in a separate conduit.
- Transducer wiring should be run in a separate trench other than high voltage wire trench if possible. Feedback errors may occur if transducer control wire is run in the same trench with high voltage.



NOTICE

AutoVac cannot be responsible for transducer feedback errors due to control wire being run in the same trench as the high voltage wire.

CHAPTER 2 - INPUT POWER, MOTOR AND PRESSURE TRANSDUCER CONNECTIONS.

With power OFF, ensure the following mechanical and electrical conditions:

- Rated output current of the VFD is equal or greater than the motor FLA.
- Supply voltage, VFD rated voltage and motor voltage match.
- Power factor correctio capacitors are **NOT** installed between the VFD and the motor.
- Power factor correction capacitors are **NOT** installed within 100m (300ft) of input to the VFD without a line reator.
- Motor and the load rotate freely.

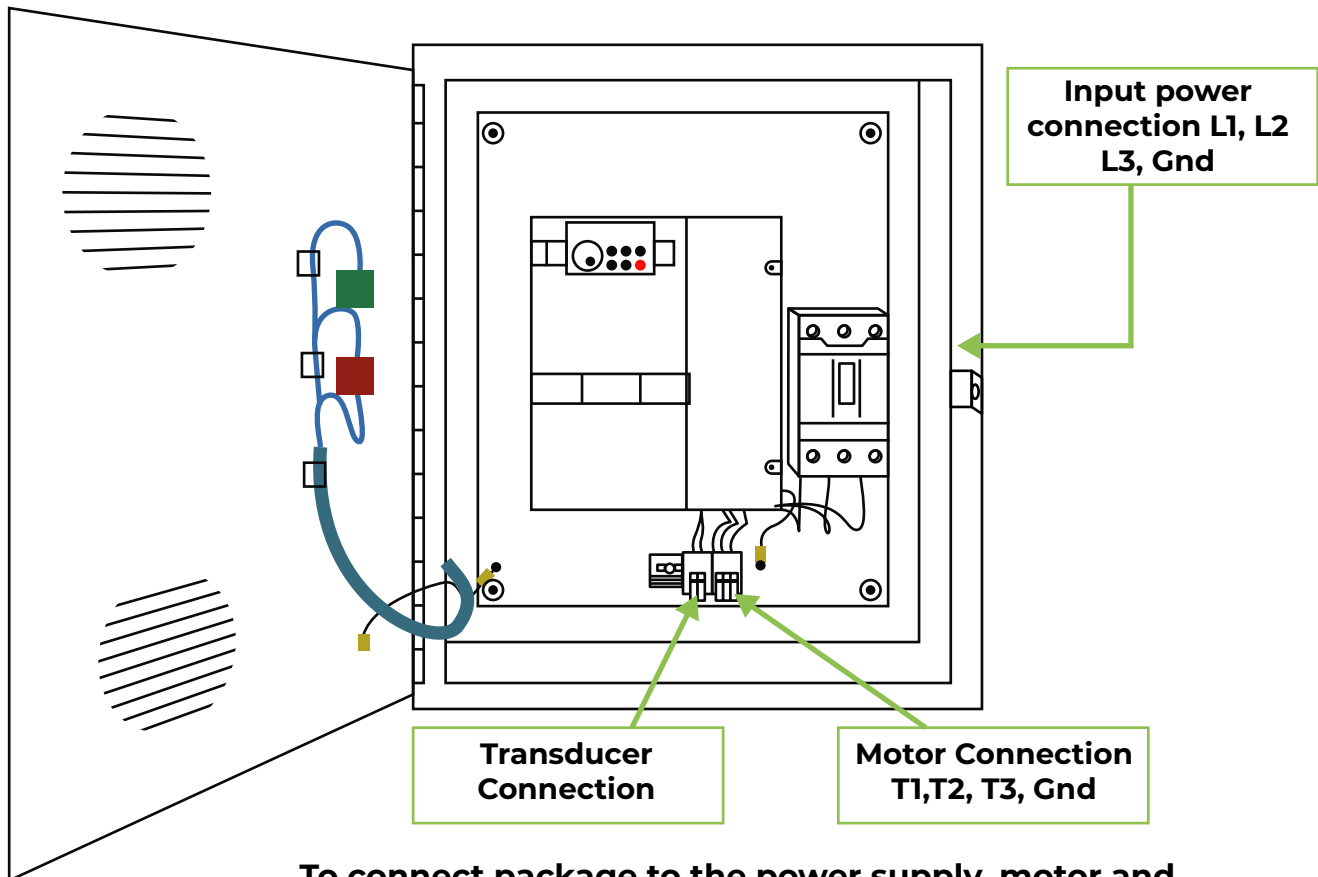

To connect package to the power supply, motor and pressure transducer please refer to picture below and Auto Cad drawings submitted in Chapter 4.

 **NOTE**

For single motor configuration, input power and transducer connections are the same. Motor connection terminals are labelled 1T1, 1T2 and 1T3.

 **CAUTION**

To prevent an electric shock always ground the motor and VFD. Use independent grounding method for the VFD. If independent grounding is impossible use common grounding as shown on the figure below.

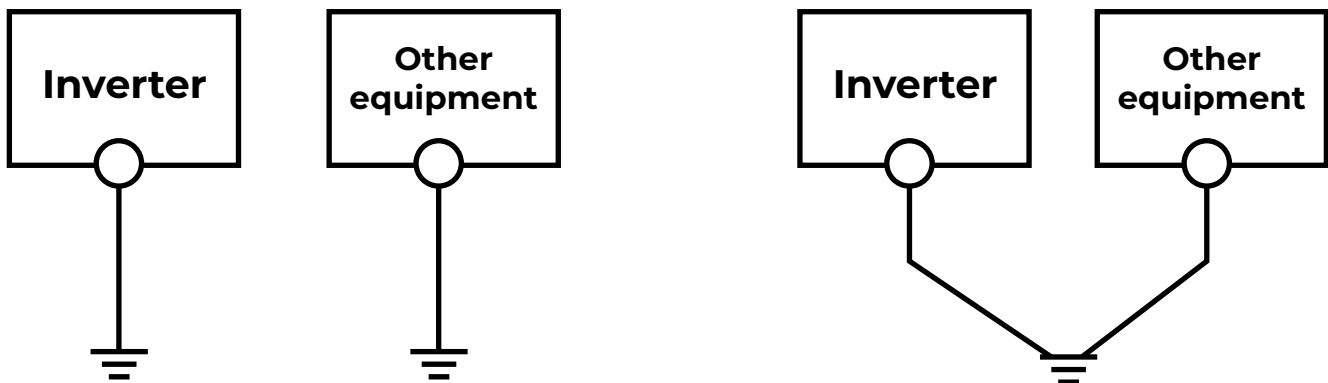

CHAPTER 3 - VFD DISPLAY OPERATION

VFD is supplied with KPC-CC01 keypad. Next chapter will explain basic KPC-CC01 operation.







KPC-CC01







Communication Interface
RJ45 (socket), RS-485 interface

Installation Method

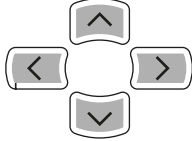

1. Embedded type and can be put flat on the surface of the control box. The front cover is water proof.
2. Buy a MKC-KPPK model to do wall mounting or embedded mounting. It's protection level is IP66.
3. The maximum RJ45 extension lead is 5m (16ft).
4. This keypad can only be used on Delta's motor drive C2000, CH2000 and CP2000.

Descriptions of keypad Functions

Key	Descriptions
	<p>Start Operation Key</p> <ol style="list-style-type: none"> 1. It is only valid when the source of operation command is from the keypad. 2. It can operate the AC motor drive by the function setting and the RUN LED will be ON. 3. It can be pressed again at stop process.
	<p>Stop Command Key. This key has the highest priority in any situation.</p> <ol style="list-style-type: none"> 1. When it receives STOP command, no matter if the AC motor drive is in operation or stop status, the AC motor drive needs to execute "STOP" command. 2. The RESET key can be used to reset the drive after the fault occurs. 3. The reasons why the error cannot be reset: <ol style="list-style-type: none"> a. Because the condition which triggers the fault is not cleared. When the condition is cleared, the fault can be reset. b. Because it's the fault status checking when power-on. When the condition is cleared, re-power again, and the fault can be reset.
	<p>Operation Direction Key</p> <ol style="list-style-type: none"> 1. This key only controls the operation direction, and will NOT activate the drive. FWD: forward, REV: reverse. 2. Refer to the LED descriptions for more details.
	<p>ENTER Key</p> <p>Press ENTER and go to the next level. If it is the last level then press ENTER to execute the command.</p>

Key	Descriptions																		
	<p>ESC Key ESC Key function is to leave current menu and return to the last menu. It also functions as a return key or cancel key in the sub-menu.</p>																		
	<p>Press menu to return to main menu. Menu content:</p> <table border="0"> <tr> <td>1. Parameter Setup</td> <td>7. Language Setup</td> <td>13. Startup Menu</td> </tr> <tr> <td>2. Quick Start</td> <td>8. Time Setup</td> <td>14. Main Page</td> </tr> <tr> <td>3. Application Selection List</td> <td>9. Keypad Locked</td> <td>15. PC Link</td> </tr> <tr> <td>4. Changed List</td> <td>10. PLC Function</td> <td>16. Start Wizard</td> </tr> <tr> <td>5. Copy Parameter</td> <td>11. Copy PLC</td> <td></td> </tr> <tr> <td>6. Fault Record</td> <td>12. Display Setup</td> <td></td> </tr> </table>	1. Parameter Setup	7. Language Setup	13. Startup Menu	2. Quick Start	8. Time Setup	14. Main Page	3. Application Selection List	9. Keypad Locked	15. PC Link	4. Changed List	10. PLC Function	16. Start Wizard	5. Copy Parameter	11. Copy PLC		6. Fault Record	12. Display Setup	
1. Parameter Setup	7. Language Setup	13. Startup Menu																	
2. Quick Start	8. Time Setup	14. Main Page																	
3. Application Selection List	9. Keypad Locked	15. PC Link																	
4. Changed List	10. PLC Function	16. Start Wizard																	
5. Copy Parameter	11. Copy PLC																		
6. Fault Record	12. Display Setup																		
	<p>Direction: Left / Right / Up / Down</p> <ol style="list-style-type: none"> In the numeric value setting mode, it is used to move the cursor and change the numeric value. In the menu/text selection mode, it is used for item selection. 																		
	<p>Function Key</p> <ol style="list-style-type: none"> The function keys have factory settings and can be defined by users. The factory settings of F1 and F4 work with the function list below. For example, F1 is JOG function, F4 is a speed setting key for adding/deleting user defined parameters. Other functions must be defined by TPEditor firts (please use version 1.60 or above). TPEditor software can be download at: http://www.deltaww.com/services/DownloadCenter2.aspx?secl-D=8&pid=2&tid=0&CID=060302&typeID=1&downloadID=&tittle=-Select Product Series --&dataType=8;&check=1&hl=en-US Please refer to instruction for TPEditor in Chapter 10-3. 																		
	<p>HAND Key</p> <ol style="list-style-type: none"> This key is executed by the parameter settings of the source of Hand frequency and hand operation. The factory settings of both of Hand frequency and hand operation are the digital keypad. Press HAND key at stop status, the setting will switch to hand frequency source and hand operation source. Press HAND key at operation status, it stops the AC motor drive first (diplay AHSP warning), and switch to hand frequency source and hand operation source. KPC-CC01 display HAND mode on the screen. 																		
	<p>AUTO Key</p> <ol style="list-style-type: none"> This key is executed by the parameter settings of the source of AUTO frequency and AUTO operation. The factory setting is the external terminal (source of operation is 4 ~ 20mA). Press Auto key at stop status, the setting will switch to hand frequency source and hand operation source. Press Auto key at operation status, it stops the AC motor drive first (diplay AHSP warning), and switch to auto frequency source and auto operation source. KPC-CC01 display AUTO mode on the screen. 																		

Descriptions of keypad Functions

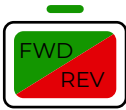
LED	Descriptions
	Steady ON: operation indicator of the AC motor drive, including DC brake, zero speed, standby, restart after fault and speed search. Blinking: drive is decelerating to stop or in the status of base block. Steady OFF: drive doesn't execute the operation command.
	Steady ON: stop indicator of the AC motor drive. Blinking: drive is in the standby status. Steady OFF: drive doesn't execute "STOP" command.
	Operation Direction LED under Torque Mode <ol style="list-style-type: none"> Green light is ON: when the torque command ≥ 0, and the motor is running forward. Red light is ON: when the torque command < 0, and the motor is running backward. Twinkling light: when the torque command < 0, and the motor is running forward.

Function of Digital Keypad KPC-CC01

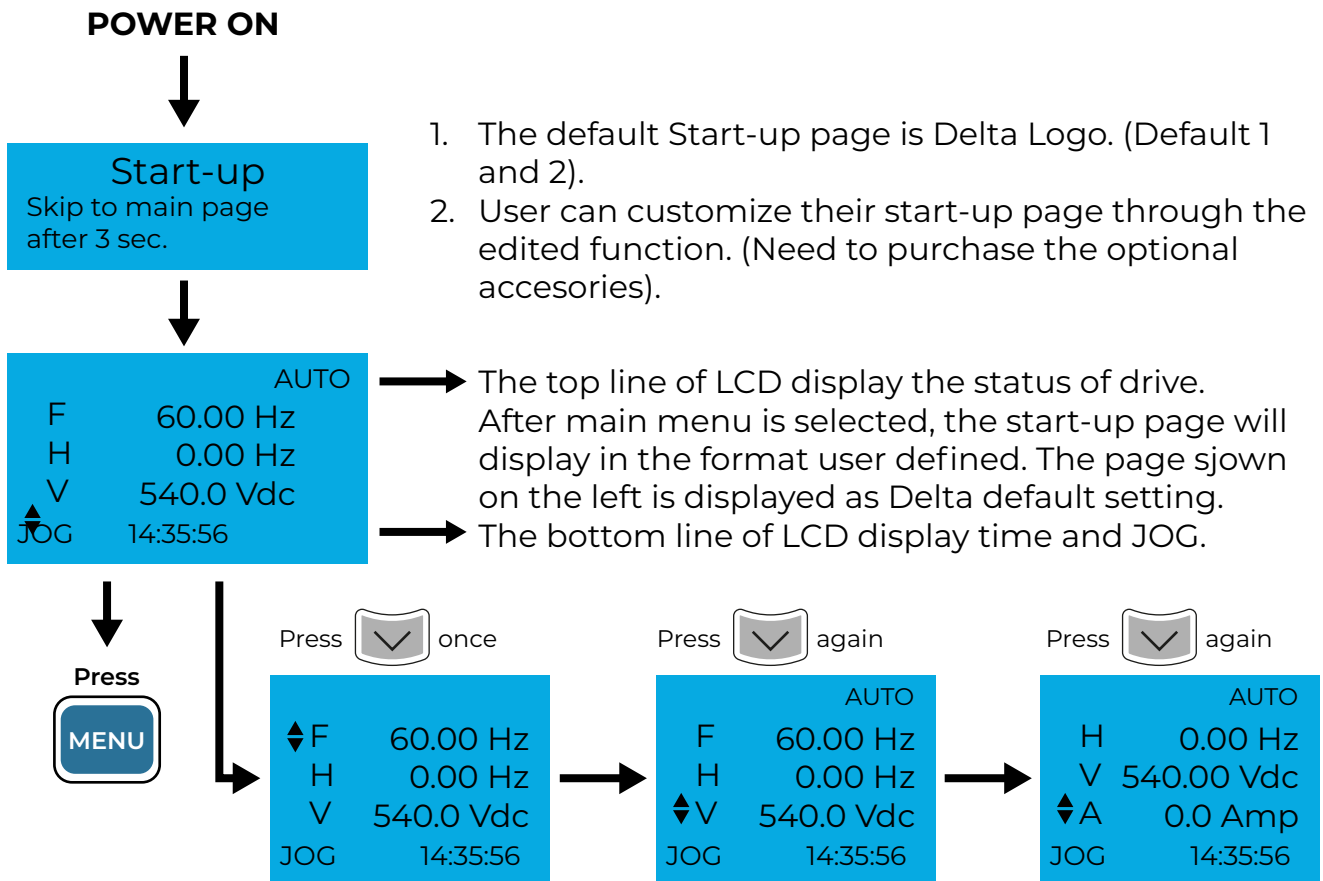

MENU

MENU

◆1: Pr Setup
2: Quick Start
3: App Sel List

- | | | |
|-------------------------------|-------------------|-------------------|
| 1: Parameter Setup | 6: Fault Record | 12: Display Setup |
| 2: Quick Start | 7: Language Setup | 13: Startup Menu |
| 3: Application Selection List | 8: Time Setup | 14: Main Page |
| 4: Changed List | 9: Keypad Locked | 15: PC Link |
| 5: Copy Parameter | 10: PLC Function | 16: Start Wizard |
| | 11: Copy PLC | |





Display Icon

Start-up

▼1: Default 1
2: Default 2
3: User define

Pr Setup

▼00: SYSTEM PAR
01: BASIC PARA
02: DIGITAL IN/▶

- : present setting
- ▼ : roll down the page for more options
- Press   for more options
- ▶ : show complete sentence
- Press   for complete information

Display Item





MENU

◆1: Pr Setup
2: Quick Start
3: App Sel List

MENU

- | | | |
|-------------------------------|-------------------|-------------------|
| 1: Parameter Setup | 6: Fault Record | 12: Display Setup |
| 2: Quick Start | 7: Language Setup | 13: Startup Menu |
| 3: Application Selection List | 8: Time Setup | 14: Main Page |
| 4: Changed List | 9: Keypad Locked | 15: PC Link |
| 5: Copy Parameter | 10: PLC Function | 16: Start Wizard |
| | 11: Copy PLC | |

Parameter Setup

<p>Pr Setup</p> <p>▼00: SYSTEM PAR 01: BASIC PARA 02: DIGITAL IN/▶</p> <p>Press  to select.</p> <p>Press   to select a parameter group.</p> <p>Once a parameter group is selected,</p> <p>Press  to go into that group.</p>	<p>For example: Setup source of master frequency command.</p> <p>00-SYSTEM PARAME</p> <p>◆00: Identity Co ▶ 01: Rated Current 02: Parameter Re</p> <p>Once in the Group 00 Motor Drive Parameter, use Up/Down key to select parameter 20: Auto Frequency Command.</p> <p>00-SYSTEM PARAME</p> <p>◆20: Source of F ▶ 21: Source of OP 22: Stop Methods</p> <p>When this parameter is selected, press ENTER key to go to this parameter's setting menu.</p> <p>00-20</p> <p>2 Analog input 0~8 ADD</p> <p>Use Up/Down key to choose a setting. For example: Choose "2 Analogue input", then press the ENTER key.</p>
--	--

	<div style="border: 1px solid black; padding: 5px; background-color: #00a0e3; color: white;">00-20</div> <hr style="border: 0; border-top: 1px solid black; margin: 5px 0;"/> <div style="border: 1px solid black; padding: 5px; background-color: #00a0e3; color: white; text-align: center;"> END Analog input </div>	After pressing the ENTER key, a END will be displayed which means that the parameter setting is done.
	<div style="border: 1px solid black; padding: 5px; background-color: #00a0e3; color: white;">00-20 Pr. lock</div> <hr style="border: 0; border-top: 1px solid black; margin: 5px 0;"/> <div style="border: 1px solid black; padding: 5px; background-color: #00a0e3; color: white; text-align: center;"> 2 Analog input 0~8 ADD </div>	NOTE: When parameter lock/password protection function is enabled, it will display "Pr. lock" on the right-up corner of the keypad. The parameter cannot be written or is protected by the password under this circumstances.

Language Setup

<div style="border: 1px solid black; padding: 5px; background-color: #00a0e3; color: white; text-align: center;"> Language </div> <hr style="border: 0; border-top: 1px solid black; margin: 5px 0;"/> <div style="border: 1px solid black; padding: 5px; background-color: #00a0e3; color: white;"> ▼1: English ▼ 2: 繁体中文 3: 简体中文 </div> <p style="font-size: small; margin-top: 10px;">Use Up/Down key to select language, than press ENTER.</p>	Language setting option is displayed in the language of the user's choice. Language setting options: <table style="width: 100%; font-size: small; margin-top: 10px;"> <tr> <td>1. English</td> <td>3. 简体中文</td> <td>5. Русский</td> <td>7. Português</td> </tr> <tr> <td>2. 繁体中文</td> <td>4. Türkçe</td> <td>6. Español</td> <td>8. Français</td> </tr> </table>	1. English	3. 简体中文	5. Русский	7. Português	2. 繁体中文	4. Türkçe	6. Español	8. Français
1. English	3. 简体中文	5. Русский	7. Português						
2. 繁体中文	4. Türkçe	6. Español	8. Français						

Language Setup

<div style="border: 1px solid black; padding: 5px; background-color: #00a0e3; color: white; text-align: center;"> Time setup </div> <hr style="border: 0; border-top: 1px solid black; margin: 5px 0;"/> <div style="border: 1px solid black; padding: 5px; background-color: #00a0e3; color: white; text-align: center;"> 2009/01/01 --:--:-- </div> <p style="font-size: small; margin-top: 10px;">Use Left/Right key to select Year, Month, Day, Hour, Minute or Second to set up</p>	<div style="border: 1px solid black; padding: 5px; background-color: #00a0e3; color: white; text-align: center;"> Time setup </div> <hr style="border: 0; border-top: 1px solid black; margin: 5px 0;"/> <div style="border: 1px solid black; padding: 5px; background-color: #00a0e3; color: white; text-align: center;"> 2014/01/01 00:00:00 </div> <p style="font-size: small; margin-top: 10px;">Use Up/Down key to set up Year</p>	<div style="border: 1px solid black; padding: 5px; background-color: #00a0e3; color: white; text-align: center;"> Time setup </div> <hr style="border: 0; border-top: 1px solid black; margin: 5px 0;"/> <div style="border: 1px solid black; padding: 5px; background-color: #00a0e3; color: white; text-align: center;"> 2014/01/01 00:00:00 </div> <p style="font-size: small; margin-top: 10px;">Use Up/Down key to set up Month</p>
	<div style="border: 1px solid black; padding: 5px; background-color: #00a0e3; color: white; text-align: center;"> Time setup </div> <hr style="border: 0; border-top: 1px solid black; margin: 5px 0;"/> <div style="border: 1px solid black; padding: 5px; background-color: #00a0e3; color: white; text-align: center;"> 2014/01/01 00:00:00 </div> <p style="font-size: small; margin-top: 10px;">Use Up/Down key to set up Day</p>	<div style="border: 1px solid black; padding: 5px; background-color: #00a0e3; color: white; text-align: center;"> Time setup </div> <hr style="border: 0; border-top: 1px solid black; margin: 5px 0;"/> <div style="border: 1px solid black; padding: 5px; background-color: #00a0e3; color: white; text-align: center;"> 2014/01/01 21:00:00 </div> <p style="font-size: small; margin-top: 10px;">Use Up/Down key to set up Hour</p>
	<div style="border: 1px solid black; padding: 5px; background-color: #00a0e3; color: white; text-align: center;"> Time setup </div> <hr style="border: 0; border-top: 1px solid black; margin: 5px 0;"/> <div style="border: 1px solid black; padding: 5px; background-color: #00a0e3; color: white; text-align: center;"> 2014/01/01 21:12:00 </div> <p style="font-size: small; margin-top: 10px;">Use Up/Down key to set up Minute</p>	<div style="border: 1px solid black; padding: 5px; background-color: #00a0e3; color: white; text-align: center;"> Time setup </div> <hr style="border: 0; border-top: 1px solid black; margin: 5px 0;"/> <div style="border: 1px solid black; padding: 5px; background-color: #00a0e3; color: white; text-align: center;"> 2014/01/01 21:12:14 </div> <p style="font-size: small; margin-top: 10px;">Use Up/Down key to set up Second</p>

Time setup

END

After setting up, press ENTER to confirm the setup.



NOTE:

Limitation: The charging process of the super capacitor will finish in about 6 minutes. **When the digital keypad is removed, the time setting will be in stanby status for 7 days.** After this period, the time need to be reset.

CHAPTER 4 - AutoCad DRAWINGS TERMINAL CONNECTION

Case 1 - Single motor

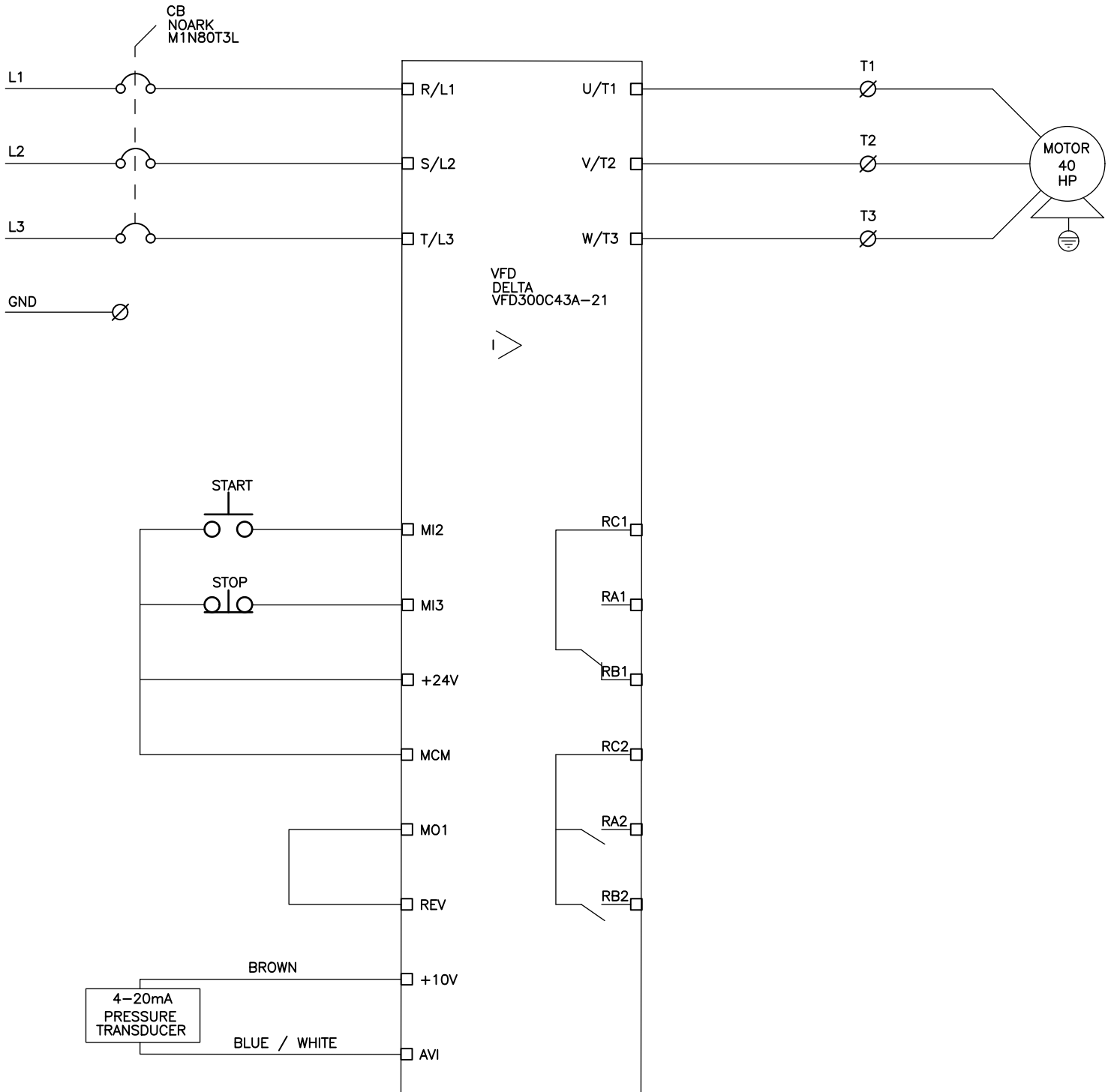

Transducer sensor wiring connections

In this page you can view the wiring connections for the four possible options of pressure transducer sensor.

Please follow the pictures to ensure a proper connection.

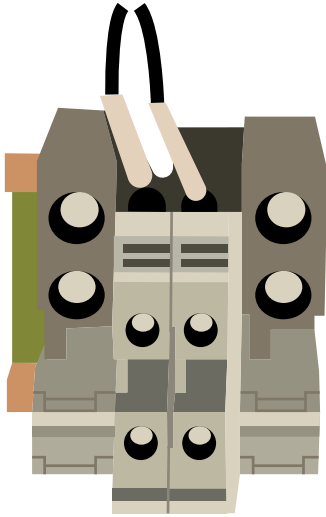

Terminal Block

The enclosure has a dedicated terminal block to wire the transducer sensor; please look up for the terminal block aside of the Motor Connection Terminal Block.

Delta VFD Enclosure

There are two wires: brown and white; brown is for the transducer power supply (**+10V**) and the white is the Analog Input to the VFD (**AV1**).

Cordset Wiring

Turck Sensor

Brand: Turck

Part No.: PT01VR-11-LI3-H1131

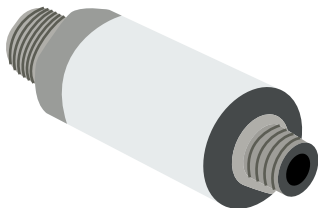

Connector A

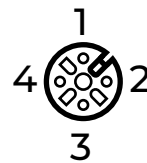

Circuit Diagram VFD TERMINAL

1)	Brown	+10V
2)	White	N.C.
3)	Blue	AV1
4)	Black	N.C.

Cordset Wiring

Brand: IFM
Part No.: PA3029

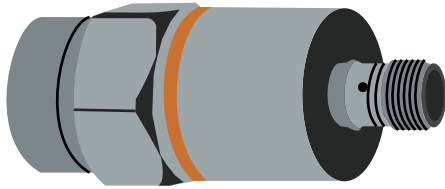

Connector A

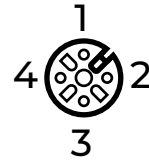

Circuit Diagram VFD TERMINAL

1)	Brown	+10V
2)	White	AV1
3)	Blue	N.C.
4)	Black	N.C.

Brand: LEFOO
Part No.: LFT2010

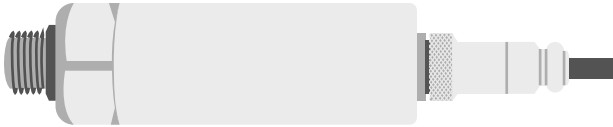

Connector A

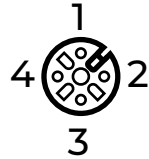

Circuit Diagram VFD TERMINAL

1)	Brown	+10V
2)	White	N.C.
3)	Blue	AV1
4)	Black	N.C.

CHAPTER 5 - VFD Parameter Settings

The Variable Frequency Drives are shipped with the parameter values shown in Parameter Tables and no further programming should be necessary. However, if additional fine tuning is required please refer to **Chapter 3, VFD Display Operation**.

5.1 - VFD Parameter Settings for Single motor configuration

Autovac Settings - Single VFD		
Parameter	Parameter Description	Setting
01-00	Maximum frequency	60 Hz
01-07	Minimum frequency	35 Hz
01-12	Acceleration time	30 sec
01-13	Deceleration time	30 sec
00-22	Stop selection	0
03-00	Analog input selection (AVI)	1
05-01	Full-load current for induction motor 1 (A)	52
05-03	Rated speed for induction motor 1 (rpm)	3599
05-04	Number of poles for induction motor 1	2
05-05	No-load current for induction motor 1 (A)	33.8
07-06	Restart after momentary power loss	2

VACUUM IQ

INTELLIGENT VACUUM CONTROLLER

QUICK START GUIDE

DELTA Variable Frequency Drive
40HP X 1 460V

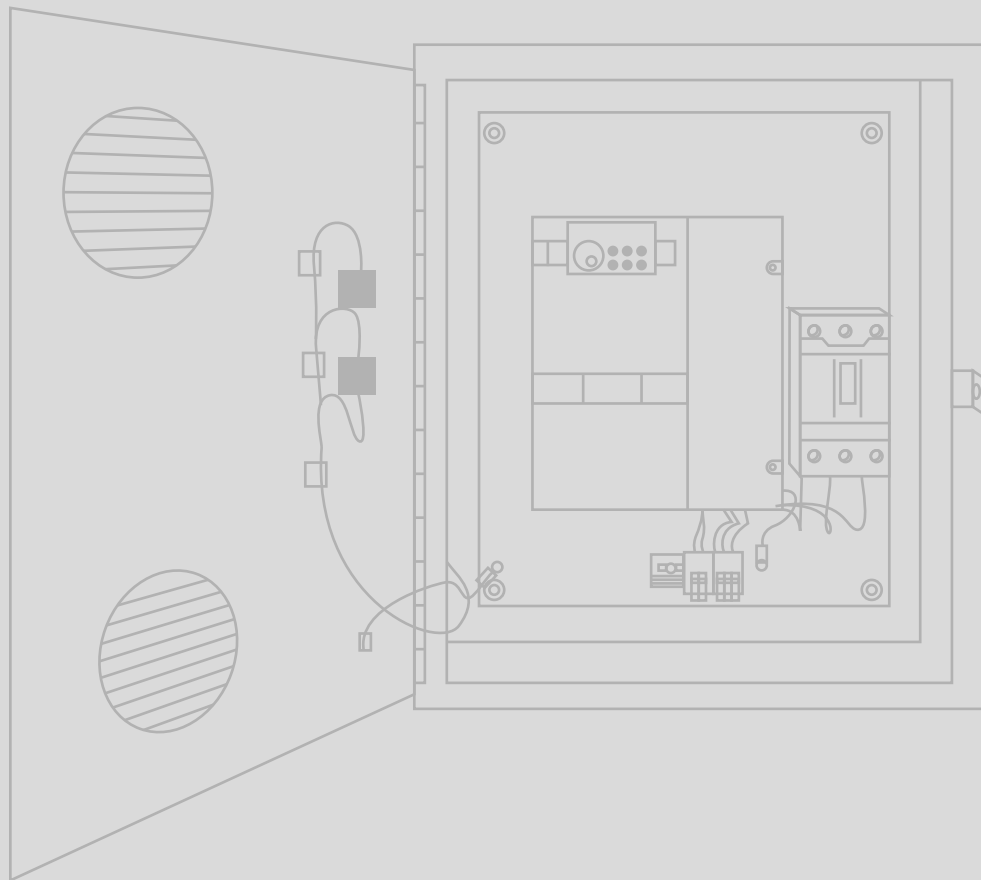

 **Sonny's CarWash
Vacuums**
by **AUT@MAC**

425-11082-DELTA