

Blower Frame System

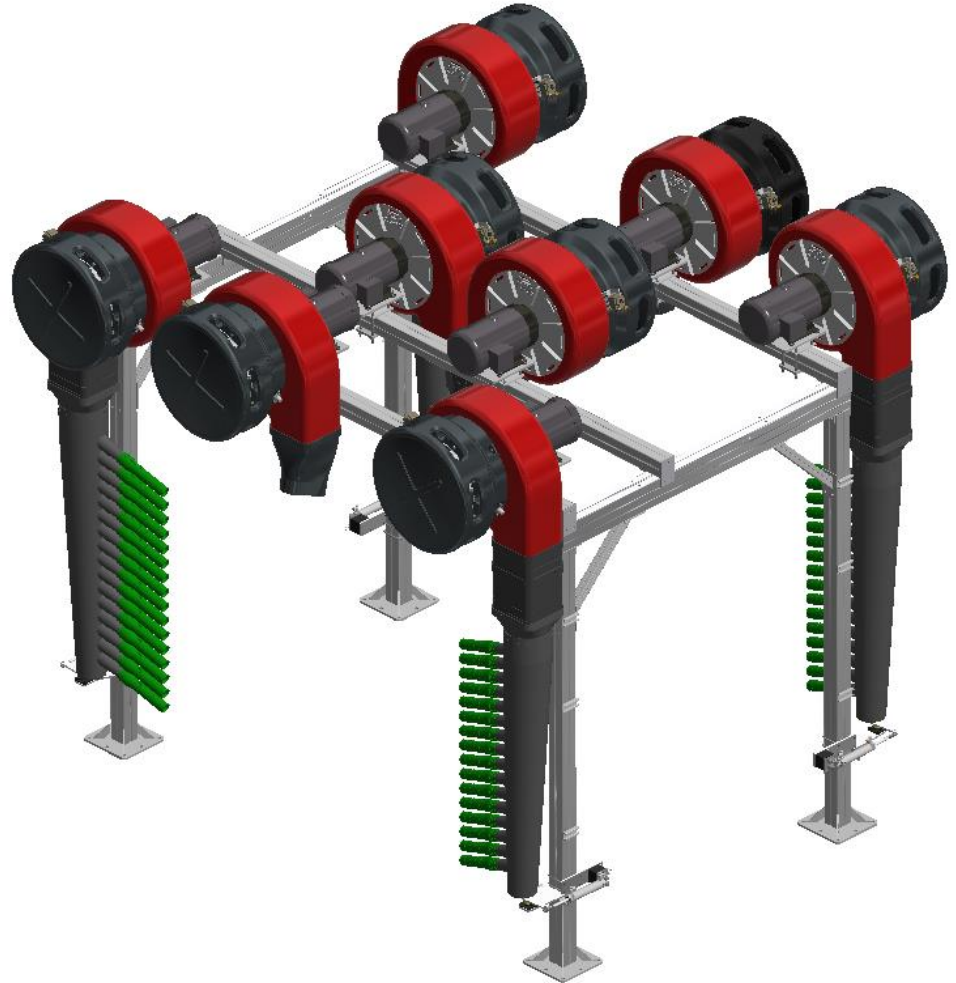

Designed here. Built here. Backed here.™

TheCarWashBook.com

www.SonnysDirect.com

Sonny's, Sonny's The CarWash Factory and Diamond Shine are registered trademarks of Sonny's Enterprises LLC
Make CarWashing Easy, OneWash, and CarWash College are trademarks of Sonny's Enterprises LLC
Profit Pilot, Wash Pilot, Buff-N-Dry, Fusion Wax and Fusion Rain Repel are trademarks of Sonny's Enterprises LLC
Sonny's Tunnel Equipment (and Design) and Mammoth Drying System Logo are trademarks of Sonny's Enterprises LLC
Designed here. Built here. Backed here. is a trademark of Sonny's Enterprises LLC
Products mentioned herein are for identification purposes only and may be registered trademarks of their respective companies.
All other brand names, trademarks or registered trademarks are the property of their respective owners.

TABLE OF CONTENTS

READ ALL INSTRUCTIONS PRIOR TO OPERATING	6
IMPORTANT SAFEGUARDS AND WARNINGS	6 - 8
SAFETY FIRST	9
INTRODUCTION	10
BLOWER FRAME SYSTEM FEATURES	11 - 13
EQUIPMENT SPECIFICATIONS	14
UTILITY REQUIREMENTS	14 - 15
CAN REDUCE WATER UTILITY COST – 60% OR MORE	15
SAFETY WEAR REQUIRED FOR INSTALLATION	16
TOOLS REQUIRED FOR INSTALLATION	16
QUICK START INSTALLATION MANUAL	16
SUB-ASSEMBLIES REQUIRED FOR BLOWER INSTALLATION	17
INSTALLATION DIMENSIONS – MUST BE VERIFIED	18 - 25
INSTALLATION OPTIONS	26 - 27
INSTALLATION BLOWER OPTIONS	28 - 29
INSTALLATION ORDER	30
MAMMOTH & V-NOZZLES INSTALLATION OPTIONS	31

CONTINUES ON NEXT PAGE



SONNY'S
Book
Service
SonnysCWS.com

Sonny's CarWash Services
LEVERAGE LOCAL SUPPORT
FLORIDA · SOUTHEAST · NORTHEAST · MID ATLANTIC · MIDWEST · TEXAS · WEST

TABLE OF CONTENTS

INSTALLATION INSTRUCTIONS	32 - 53
STAND-ALONE FRAME INSTALLATION	33
MAIN FRAME INSTALLATION	34 - 35
BLOWER INSTALLATION – LEFT SIDE ON BEAM	36 - 37
BLOWER INSTALLATION – RIGHT SIDE ON BEAM	38 - 39
BLOWER INSTALLATION – LEFT SIDE ON LEG	40 - 41
BLOWER INSTALLATION – RIGHT SIDE ON LEG	42 - 43
BLOWER INSTALLATION – ON BEAM CENTER LEFT	44 - 45
BLOWER INSTALLATION – ON BEAM CENTER RIGHT	46 - 47
BLOWER INSTALLATION – ONTO FRAME	48 - 49
MAMMOTH INSTALLATION	50 - 52
V-NOZZLE INSTALLATION	53
MAINTENANCE	54

CONTINUES ON NEXT PAGE



TABLE OF CONTENTS

WEAR ITEMS AND REPLACEMENT PARTS	55 - 64
Sonny's CarWash College™	65
CUSTOMER SERVICE & TECHNICAL SUPPORT	66
HOW CAN WE HELP YOU?	67
WARRANTY	68
ONLINE PRODUCT MANUALS & TECH BULLETINS	69
FREE NEWSLETTERS AND ALERTS	70
FREE CAR WASH CATALOGS & BOOKS	71
EMERGENCY CONTACTS	71
UNLIMITED WASH CLUB	72
BOOST YOUR SALES	73
WHAT YOU SEE IS WHAT YOU GET	73
CONTROL YOUR PROFITABILITY	74
SECURITY AT YOUR FINGERTIPS	74
GROW YOUR BUSINESS	75
TOTAL SOLUTION	76
THIS IS WHO WE ARE	77

Make CarWashing Easy™

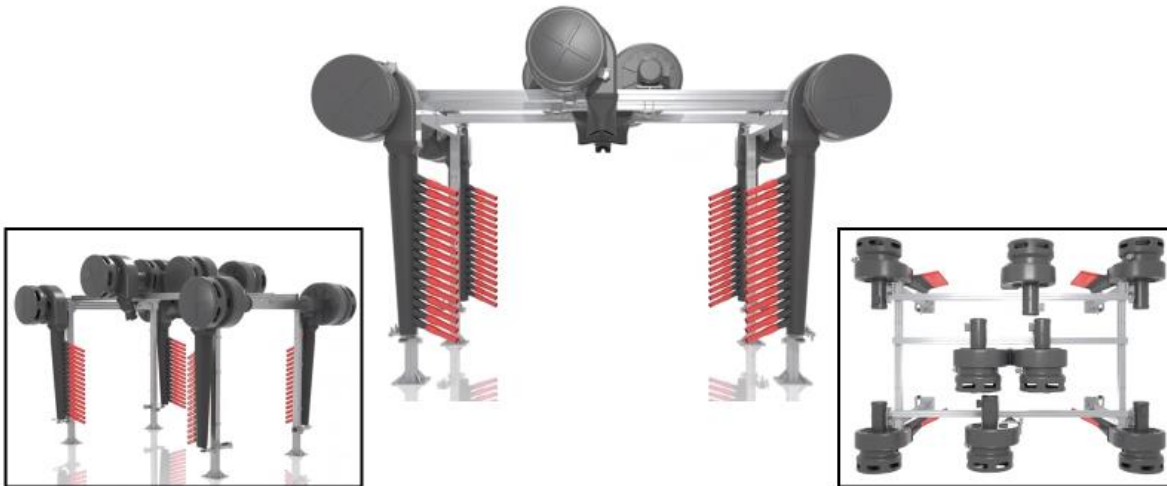



READ ALL INSTRUCTIONS PRIOR TO OPERATING

- This manual is a comprehensive step-by-step user instruction guide for the **Blower Frame System** and components. To review other manuals go online to SonnysDirect.com under Support Tab.
- Make sure to read, understand and follow all these instructions.
- To address any questions relating to ordering parts, operating the **Blower Frame System**, installation, troubleshooting, maintenance, service or anything else, contact **Sonny's Technical Support Team at 1-800-327-8723**.
- All deviations and alterations from these instructions **MUST** be reported to Sonny's The CarWash Factory®. **Keep this manual in a location where it may be used for ongoing reference.**



IMPORTANT SAFEGUARDS AND WARNINGS

- **WARNING: Do not perform any maintenance or work on equipment unless you first perform Lock-Out Safety Precautions. All electrically powered equipment MUST have manually operated disconnects capable of being locked in the "OFF" position. Equipment that has been "locked out" for any reason must be restarted ONLY by the person who performed the "lock out" operation. These procedures MUST be followed to avoid personal injury, death and/or dismemberment.**
- All parts and components **MUST** be installed by experienced and trained technicians.
- **No** unauthorized personnel should ever be permitted in the wash tunnel or near the equipment at any time.
- Hardhat, safety glasses with side shields, closed steel toe shoes, anti-impact and cut resistant gloves, dust mask, and earplugs if operating power tools, **MUST** be worn.
- When cutting or grinding any metal, safety glasses, earplugs, and dust mask **MUST** be worn.
- **Do NOT leave a ladder or any other items such as wash down hoses or tools in the wash tunnel while equipment is running. Vehicle damage and injury, including death, can occur.**
- **Do NOT wear loose fitting clothing or jewelry around moving equipment. Do not allow any part of your body or other objects (including ladders, hoses, or tools) to come in contact with moving equipment. Entanglement may result causing injury, death, or dismemberment.**
- Always exercise caution when walking (never run) through the wash tunnel as there may be slippery conditions. Be careful so you do not bump into or trip over equipment.



IMPORTANT SAFEGUARDS AND WARNINGS

- **Electrical connections and repairs MUST ONLY be performed by a Licensed Electrician.**
- **Plumbing connections and repairs MUST ONLY be performed by a Licensed Plumber.**
- When working on any equipment that is higher than your shoulders, always use a fiberglass ladder that is in good condition.
- Use proper lifting technique. Team lifts are required for items over 50 lbs.
- Do **NOT** alter or modify parts in any way and do **NOT** interchange or substitute any components without the authorization of your supervisor and Sonny's The CarWash Factory.
- Do **NOT** install any parts or components into faulty materials.
- All damages and defects **MUST** be reported to both your supervisor and Sonny's The CarWash Factory.
- If there are any malfunctions with the **Blower Frame System** or if any questions arise regarding the equipment operations, immediately contact your supervisor or Sonny's The CarWash Factory.
- **Only** use approved hardware, parts, and components with the **Blower Frame System** or any other equipment.
- Protect your body parts against sharp corners and edges at all times.
- Keep loose articles of clothing and jewelry away from the removal, installation, or operation of all equipment.
- The personnel installing the **Blower Frame System** are responsible for making sure it works according to the instructions in this manual.
- Always remove ladders, tools, parts, etc, from the wash tunnel when finished.
- All personnel **MUST** be trained in the safe operation of all equipment, wash tunnel operations, safety regulations, emergency shutdown and maintenance practices to avoid any accidents.
- **Only** personnel specifically instructed and trained are permitted to enter the wash tunnel to perform inspections or maintenance. At least two qualified maintenance personnel **MUST** be present when performing equipment repairs or preventive maintenance.
- **IMPORTANT:** Call Technical Support to adjust wash cycle when new equipment is installed.
- **WARNING:** All hydraulic and electrical systems in the wash tunnel equipped with torque relief or overload should be checked and set to the minimum amount that will allow for proper functionality under normal washing conditions.



IMPORTANT SAFEGUARDS AND WARNINGS

- **WARNING:** Possible wet floors and slippery conditions! To avoid an accident that might result in personal injury, death or dismemberment, all personnel **MUST** proceed with Caution.
- **WARNING:** Do **NOT** enter the wash tunnel when the equipment is operating. Personal injury, death and/or dismemberment may occur.
- **WARNING:** Make sure the proper Chemistry (Brush Lubrication) is being used in the Car Wash Tunnel to prevent vehicle and/or equipment damage.
- **WARNING:** If the Equipment Installation Dimensions at the time of installation are **NOT** measured correctly, it may result in equipment damage and/or failure. Dimensions **MUST** be verified if equipment is already installed. Contact Sonny's Technical Support Team at 1-800-327-8723 for any Installation questions.
- **WARNING:** All connections and repairs **MUST ONLY** be performed by Licensed Professionals. Perform all trade work in compliance with all applicable local and national codes.
- **WARNING:** Although building codes have been considered in developing all drawings, verification of site-specific conditions and compliance with federal, state, and local building codes is the exclusive responsibility of the customer and/or architect and engineer to verify compliance.
- **WARNING:** Do **NOT** attempt to repair or adjust any pressurized liquid or pneumatic part, hose, pipe, or fitting while that equipment is in operation.
- **WARNING:** Do **NOT** operate any equipment that requires safety covers with those covers removed or improperly installed. Do **NOT** operate any equipment if any component of that equipment is suspected to be defective or malfunctioning.
- **WARNING:** Store all cleaning, washing solutions and oils in a well-ventilated area. Clean up fluid spills immediately to prevent hazardous safety conditions. Be certain to follow all safety procedures on SDS Sheets for each chemical product used.
- **WARNING:** When a piece of equipment must be in operation during inspection or maintenance, one qualified technician must stay at the power disconnect switch while another qualified technician performs the inspection or maintenance.
- **WARNING:** All Equipment **MUST** be given regular maintenance to prevent equipment damage and/or failure that will **VOID** the warranty.
- **WARNING: Emergency "STOP" Buttons MUST** be well marked, and their location and proper use reviewed with all personnel. Any activated "STOP" button must be reset only by the person who activated it. Clear the wash tunnel of any people, ladders, hoses, tools, and other loose items before restarting the equipment. An audible device **MUST** sound to warn people that the equipment is starting.

SAVE THESE INSTRUCTIONS

SAFETY FIRST

SONNY'S
Lock-Out
Tag-Out

Safety First

Verify Safe Working Conditions

Ladder Safety

SONNY'S
Safety Kit



Qualified Technician

Tunnel Install

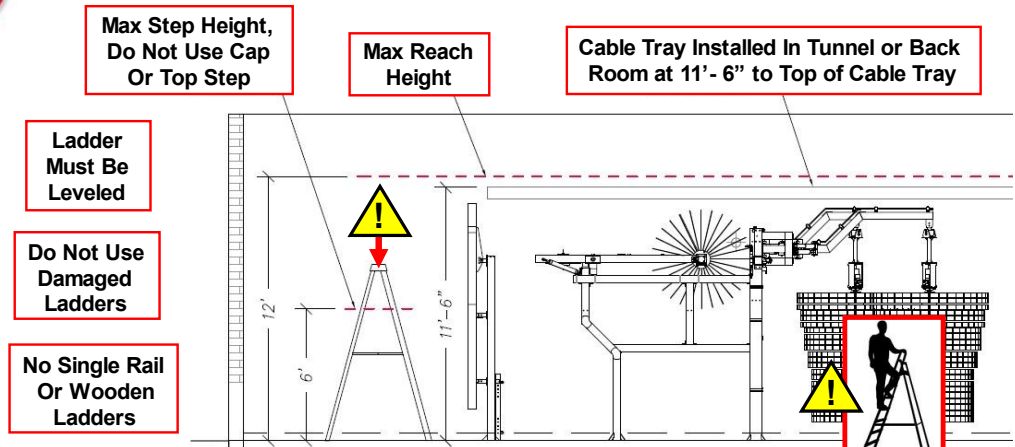

- Ladder Must Only be Used for What it was Designed for
- Do Not Exceed Max Weight Limit
- Personnel Must Not Carry Any Objects that Will Cause Them to Lose Balance
- Personnel Must Face Ladder When Climbing and Going Down the Ladder

Prevent Injuries

Canopy Install

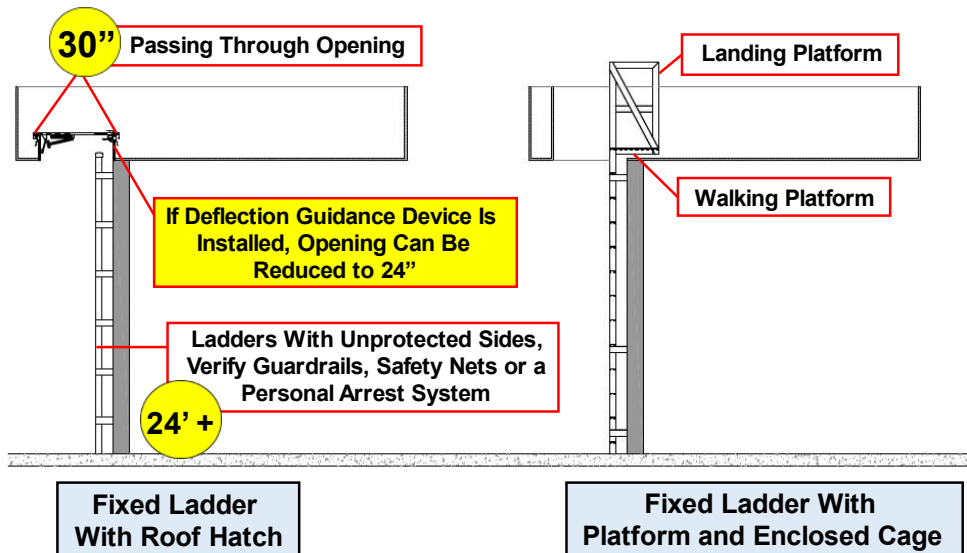

INTRODUCTION



Make CarWashing Easy

<p>Sonny's CarWash Consulting</p> <p>Consulting</p> <p>INVEST WITH CONFIDENCE</p>	<p>Sonny's CarWash College</p> <p>College</p> <p>MASTER YOUR TRADE</p>	<p>Sonny's CarWash Equipment</p> <p>Equipment</p> <p>WASH MORE CARS</p>	<p>Sonny's CarWash Services</p> <p>Services</p> <p>LEVERAGE LOCAL SUPPORT</p>
<p>Sonny's CarWash Vacuums</p> <p>Vacuums</p> <p>MAXIMIZE CUSTOMER EXPERIENCE</p>	<p>Sonny's CarWash Controls</p> <p>Controls</p> <p>DRIVE BUSINESS FORWARD</p>	<p>Sonny's CarWash Marketing</p> <p>Marketing</p> <p>WIN EVERY CUSTOMER</p>	<p>Sonny's CarWash Signage</p> <p>Signage</p> <p>INCREASE YOUR TICKET</p>
<p>Sonny's CarWash Chemistry</p> <p>Chemistry</p> <p>MAKE CARS SHINE</p>	<p>Sonny's CarWash Backroom</p> <p>Backroom</p> <p>IMPROVE APPLICATIONS EFFICIENCY</p>	<p>Sonny's CarWash Water</p> <p>Water</p> <p>OPTIMIZE EVERY DROP</p>	<p>Sonny's CarWash Parts</p> <p>Parts</p> <p>KEEP ON WASHING</p>

Learn More at:
www.SonnysDirect.com/onewash

BLOWER FRAME SYSTEM FEATURES

 The entire Blower Frame System works together to dry every inch of the vehicle in record time; by delivering a fluid motion over all surfaces for a more consistent drying experience across a wider range of vehicles. Sonny's Blowers maximize the drying performance with optimal results and maximum flexibility. The Blower Frame System lets you mount 10 blowers with up to 150 HP in fewer legs for a cleaner, more open drying space. The multi-functional Air Dryers and Pivoting Mammoth completes the car washing experience, so your customers keep coming back for more.

- **8 Blowers** with 120 HP, **10 Blowers** with 150 HP, and **13 Blowers** with 195 HP
- **Different Impeller Options:** With 10 HP, 15 HP, and Mammoth 15 HP
- Frame and legs are constructed from aluminum with optional finish powder coating in multiple color choices

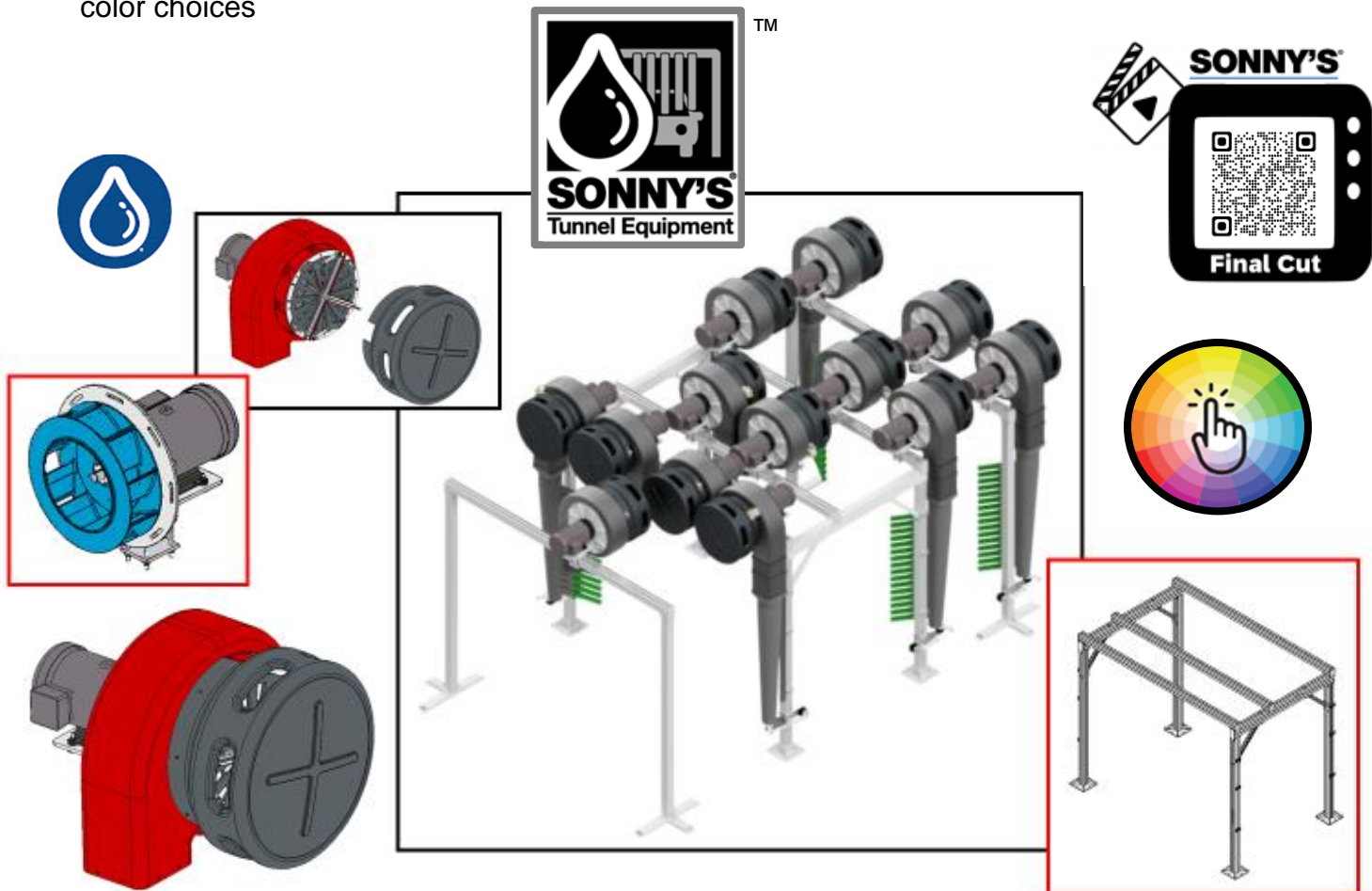

BLOWER FRAME SYSTEM FEATURES

 Increase Sonny's Blowers optimized efficiency by installing the **V-Nozzles** on the middle blowers and the **Mammoth Drying System** on the end Blowers.

- **Single V-Nozzle:** Moves water off the vehicle and down the sides
- **Double V-Nozzle:** Moves large volumes of water off the vehicle, directs air from the center and down the sides for consistent results at high chain speeds
- **Half V-Nozzle:** Targets hard-to-dry areas like side mirrors and rockers; and by combining the Half V-Nozzles in split configurations it addresses specific needs for maximum coverage
- **Flip V-Nozzle:** Dries the back of SUVs from the license plate to under the deepest top molding; it also splits the air down the center for the most effective drying on a rear hatch we've ever achieved
- **Pivoting Mammoth Dryer:** Dries the rear glass and vehicle's bumpers at conveyor speeds up to 140 cars per hour; while the pivoting option promotes powerful and precise drying with full-range coverage as the vehicle passes

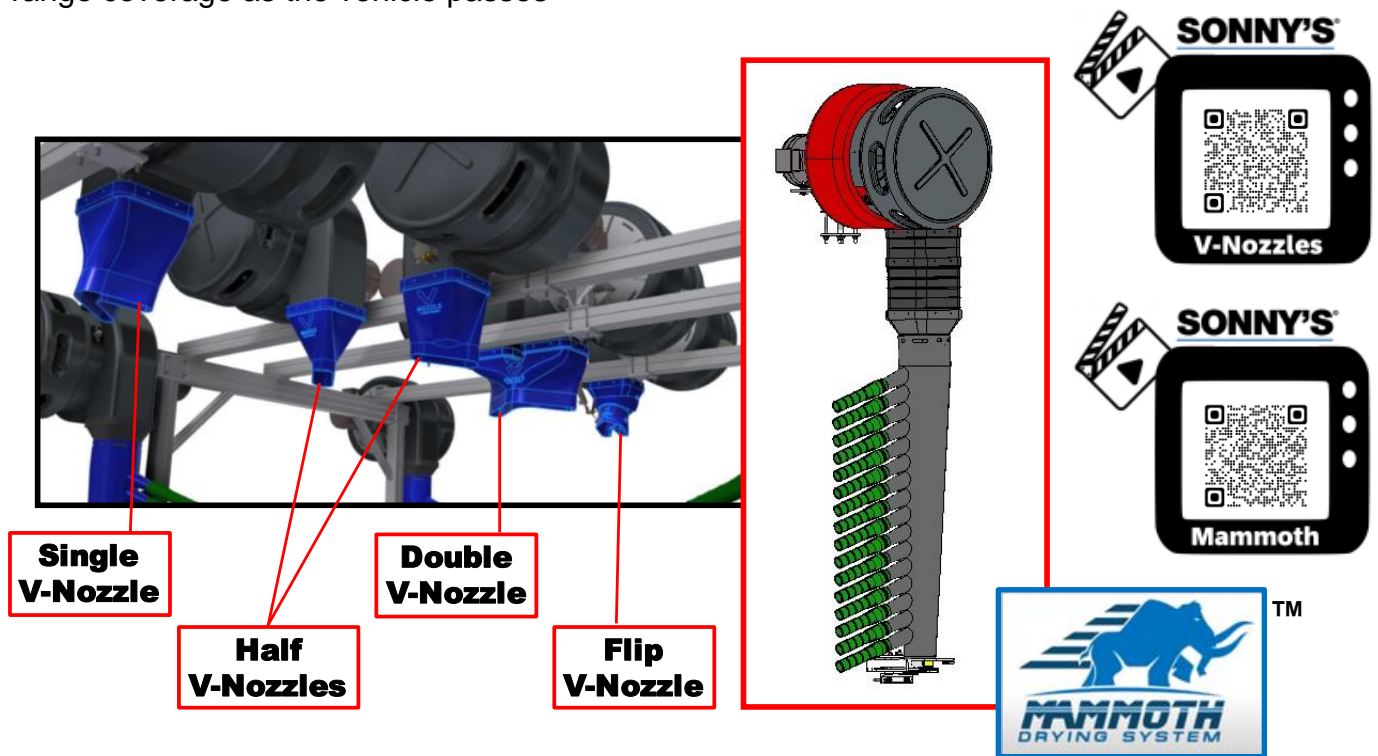

BLOWER FRAME SYSTEM FEATURES

 Gain flexibility in complying with noise ordinances that limit the allowable noise levels in some zoned areas. The **Blower Silencer™** retrofits to an existing Sonny's Blower to reduce noise level by up to 7 decibels at 50 feet depending onsite specific architectural and other variables.

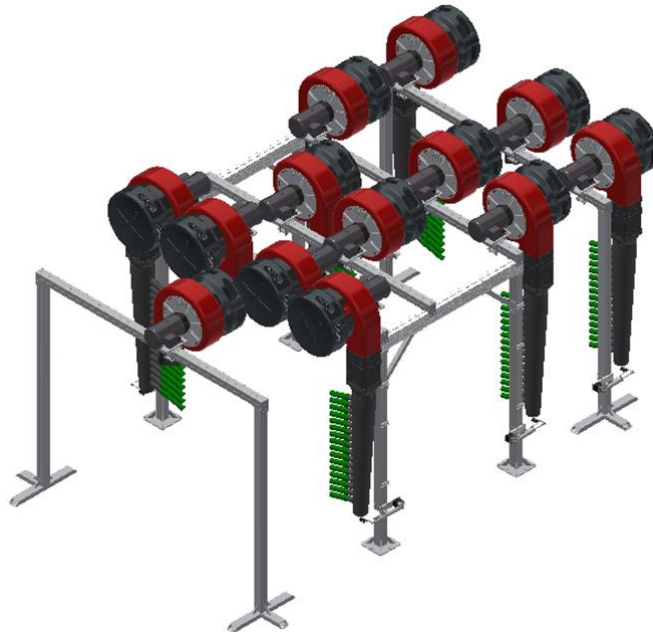

EQUIPMENT SPECIFICATIONS

Footprint Length	<p>97" – 8 Blowers</p> <p>172" – 10 Blowers</p> <p>235" – 13 Blowers</p>
Footprint Width	<p>130" Beams</p> <ul style="list-style-type: none"> • 138" – 8 Blowers • 154" – 10 to 13 Blowers <p>144" Beams</p> <ul style="list-style-type: none"> • 152" – 8 Blowers • 168" – 10 to 13 Blowers
Unit Height	132"
Vehicle Clearance	90"

UTILITY REQUIREMENTS



CAUTION: Do not use wire nuts to connect 3 phase wiring at the electric motor terminal box. Only use split bolt type connectors with electrical insulation tape and rubber insulator boots.

Typical split bolt connector.

Use to connect 3-phase wiring at electric motor terminal box.



UTILITY REQUIREMENTS

Utilities interconnection and the materials required for interconnection to Sonny's equipment are the responsibility of the customer

- ⚠ **All connections and repairs MUST ONLY be performed by Licensed Professionals. Perform all trade work in compliance with all applicable local and national codes.**



Compressed Air - The Customer's Plumber is responsible for:

- The installer is to provide materials and install a 3/8" compressed air line from the Air Compressor to and from the supplied air regulator, 4-way air solenoid valves, and air cylinder on the Dryer Producer Assembly. Compressed Air requirement is approximately 1.5CFM at 60PSI.

Electric - The Customer's Electrician is responsible for:

- The Customer's Electrician is to provide materials and install single phase power from the Customer's equipment programmer (Equipment Start-Stop System) to the actuation controls for each electric motor on the Blower.
- The Customer's Electrician is to provide materials and install 3-phase power (see voltage options below) to the Blowers Electric Motors on the Blower Frame System through properly sized 3 pole circuit breakers and motor starters with 3 thermal overloads.
- **WARNING:** Make sure all motors are properly wired for the supply voltage being used.

Voltage Options

- 208V / 3-Phase / 60 Hz
- 230V – 460V / 3-Phase / 60 Hz
- 190V – 380V / 3-Phase / 50 Hz

⚠ **Technical Disclaimer**

Stargate™ Operating Pressure: 20psi

Flip V-Nozzle Operating Pressure: 20 - 30psi

Pivoting Mammoth Cylinder Operating Pressure: 30psi

Although building codes have been considered in developing all drawings, verification of site-specific conditions and compliance with federal, state, and local building codes, it is the exclusive responsibility of the customer and/or architect and engineer to verify compliance.

SAFETY WEAR REQUIRED FOR INSTALLATION

⚠ WARNING: Make sure to follow Local and State Safety Wear Required Regulations to ensure the safety of all personnel. Failure to follow Safety Regulations may result in personal injury, death and/or dismemberment.

TOOLS REQUIRED FOR INSTALLATION

Tools	Tools
Forklift and 2 Ladders	Tape Measure and Never•Seez®
Safety Glasses and Gloves	4" Level and Pry Bar
Impact Gun and Sockets	Permanent Marker
1/2" Drive Ratchet Set	PTFE Paste or PTFE Tape
Standard Combo Wrenches	Large Standard Screwdriver
1" Hammer Drill	Lifting Straps and Stainless Shims
3 lb. Sledgehammer	Handheld Saw

QUICK START INSTALLATION MANUAL

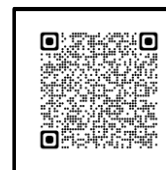

Go online to SonnysDirect.com under Support Tab and look for:

QUICK START MANUAL
Blower Frame System

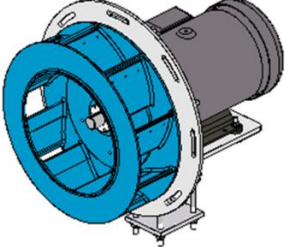
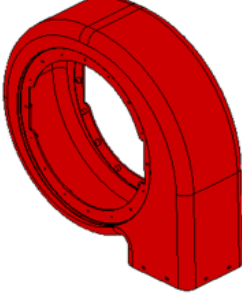

SUB-ASSEMBLIES REQUIRED FOR BLOWER INSTALLATION

The following sub-assemblies are included with shipment:

<p>Motor & Impeller</p>	<p><u>Impeller Options</u></p> <p>10 HP 15 HP 15 HP Mammoth</p>	
<p>Housing</p>	<p><u>Color Options</u></p> <p>Black Red Blue</p>	
<p>Stargate™ & Venturi</p>	<p><u>Venturi Color Options</u></p> <p>Black Red Blue</p>	
<p>Silencer Optional</p>	<p><u>Color Options</u></p> <p>Black Red Blue</p>	

INSTALLATION DIMENSIONS

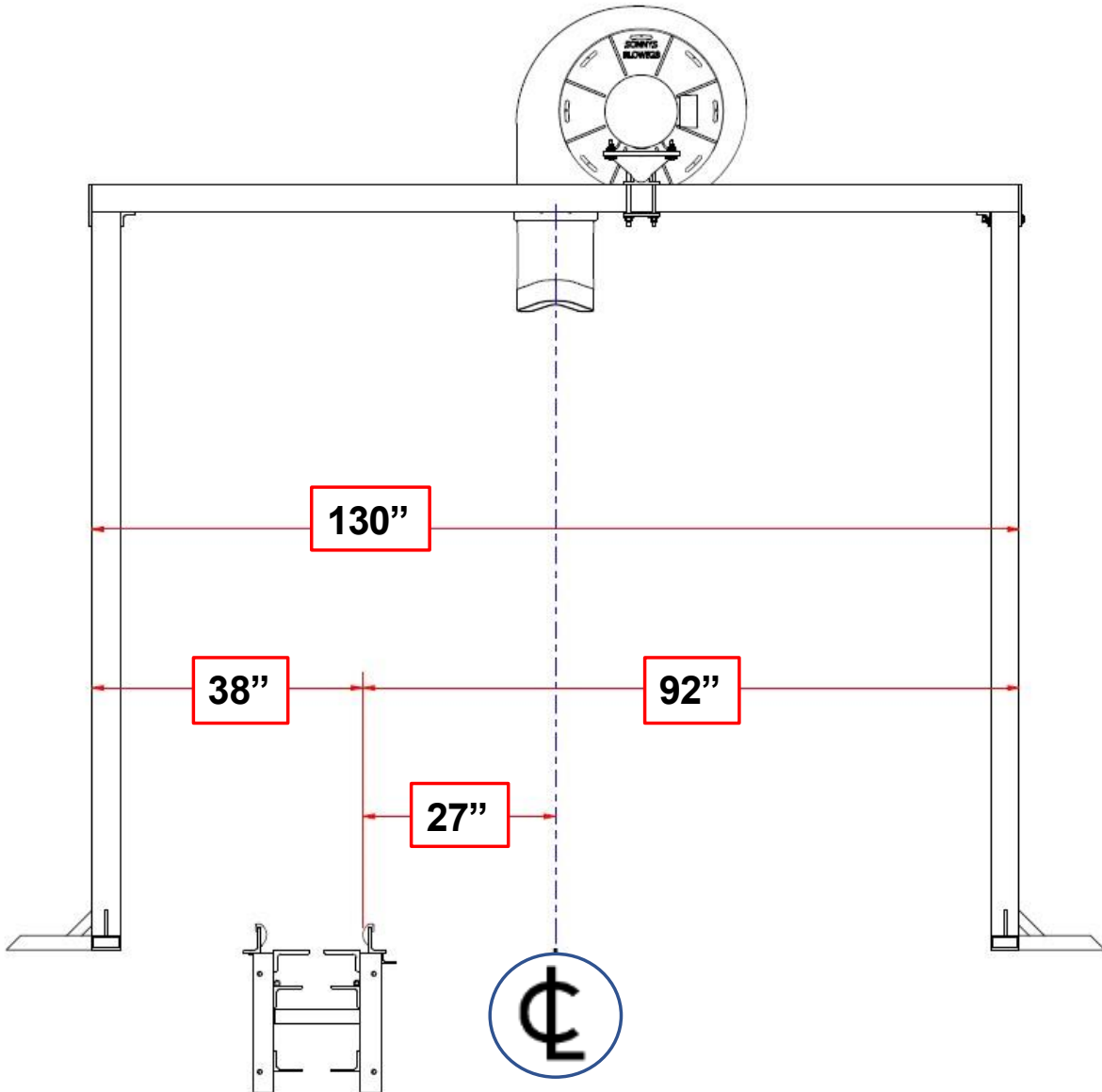

INSTALLATION DIMENSIONS

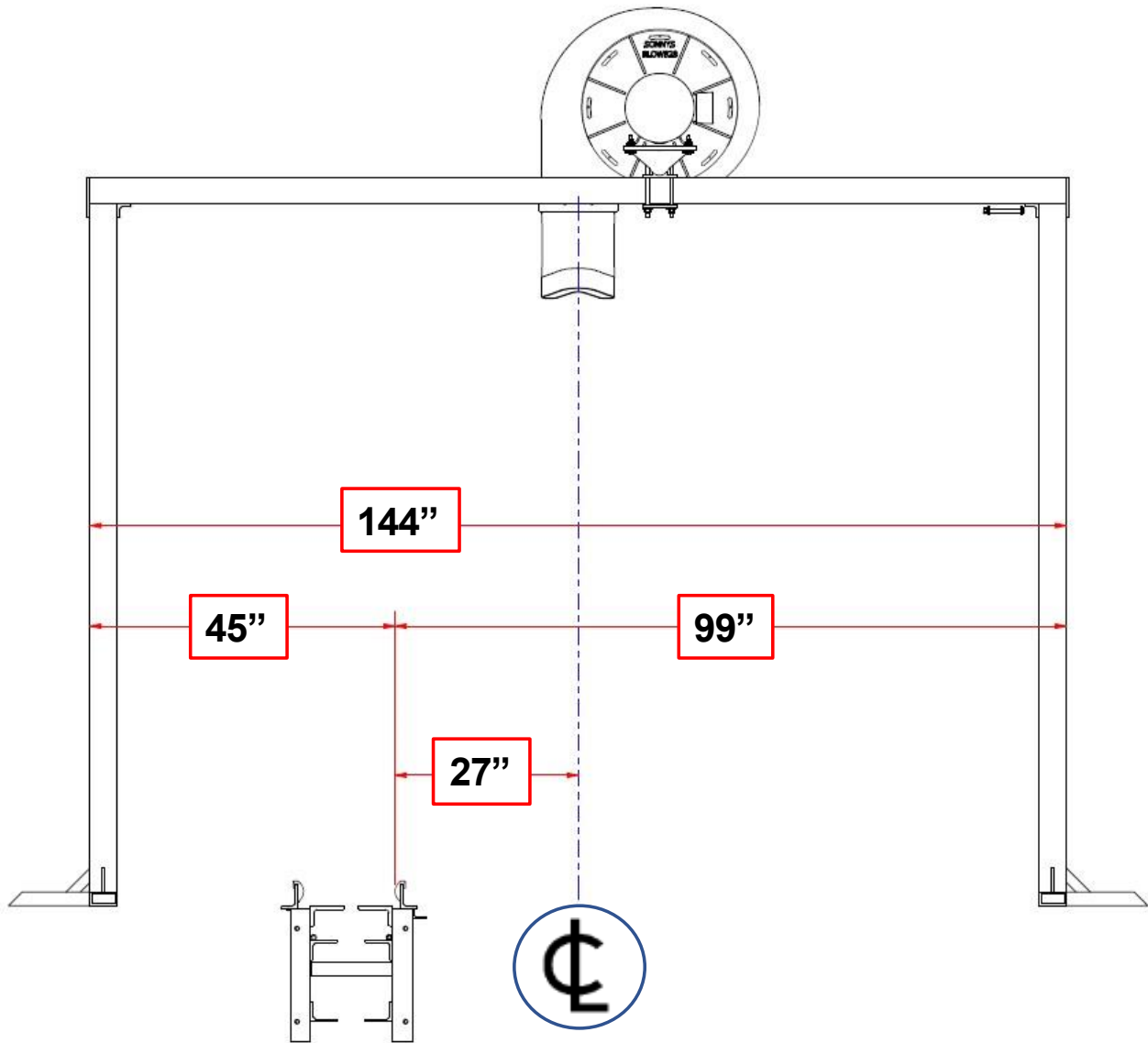

INSTALLATION DIMENSIONS

Beam Install

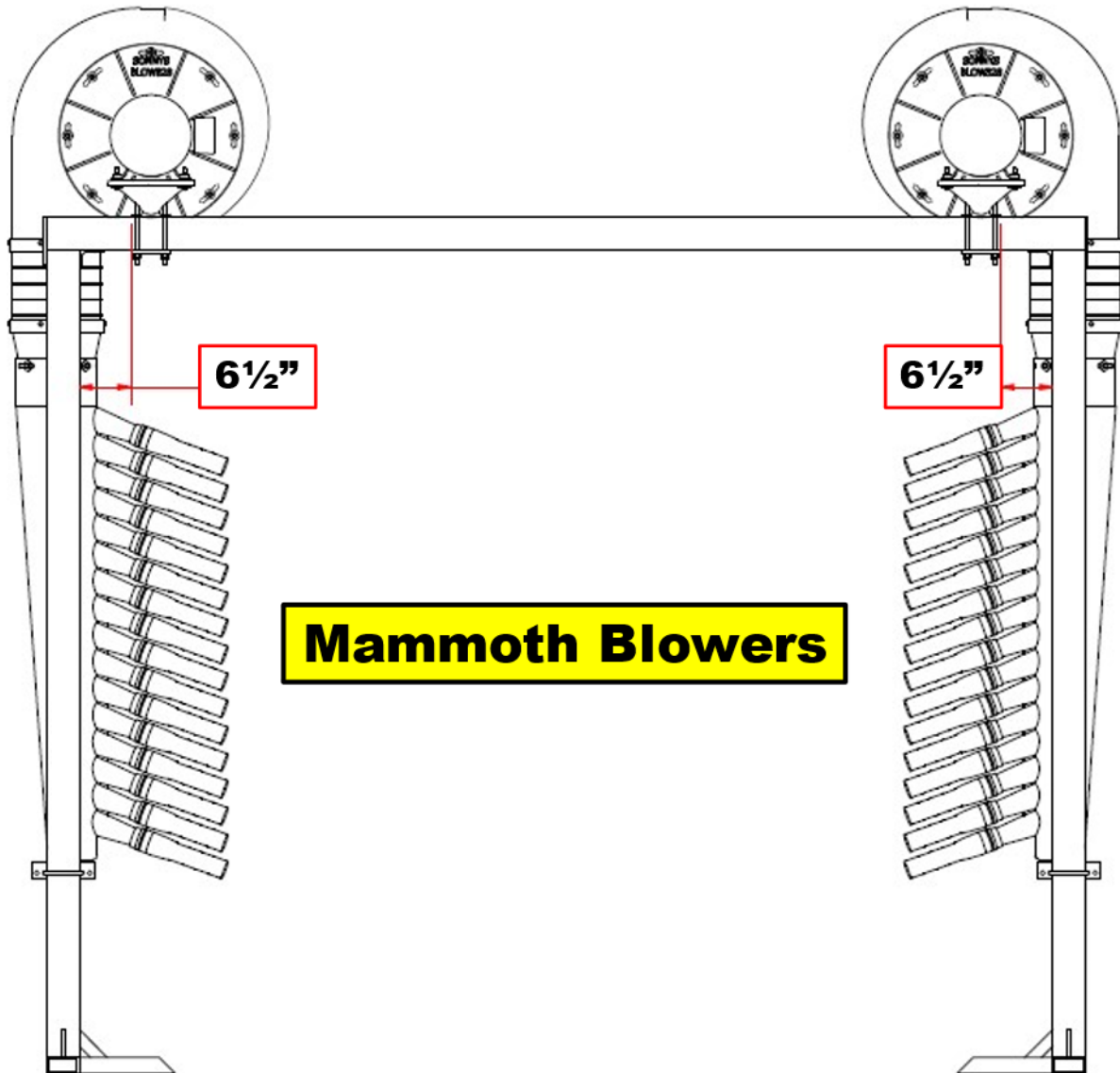

INSTALLATION DIMENSIONS

Leg Install

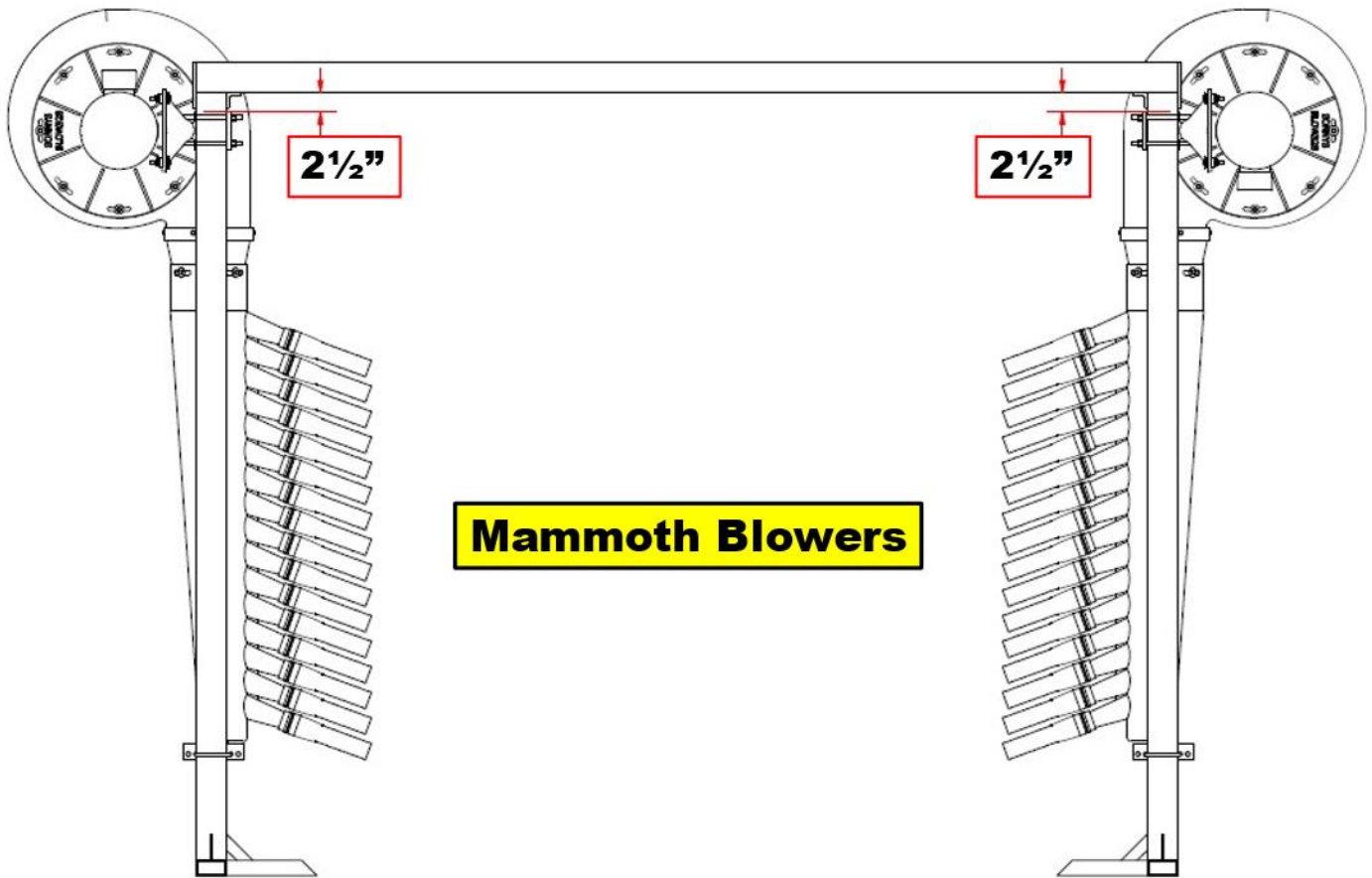

INSTALLATION DIMENSIONS

One Blower Single V-Nozzle

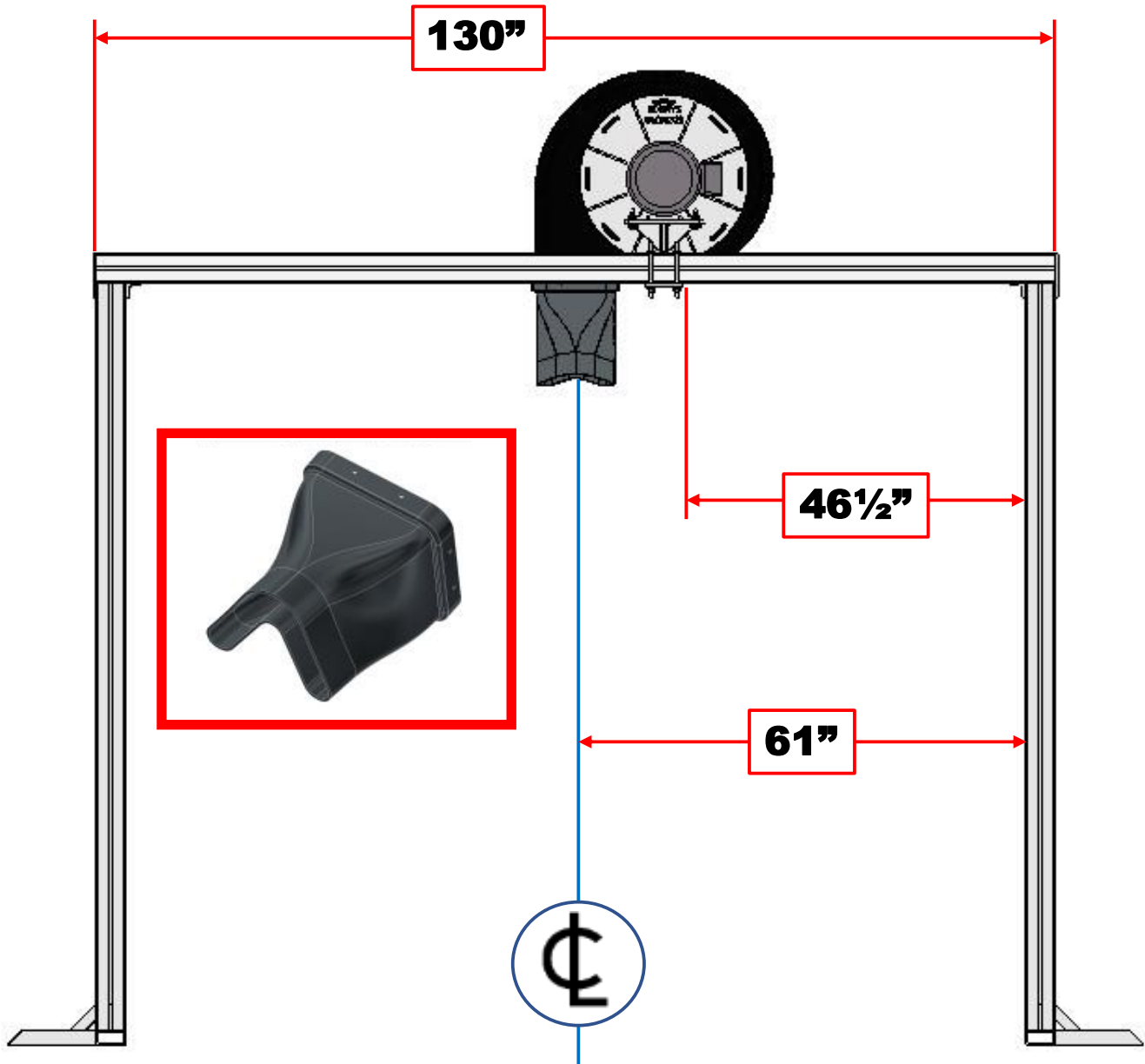

INSTALLATION DIMENSIONS

One Blower Flip V-Nozzle

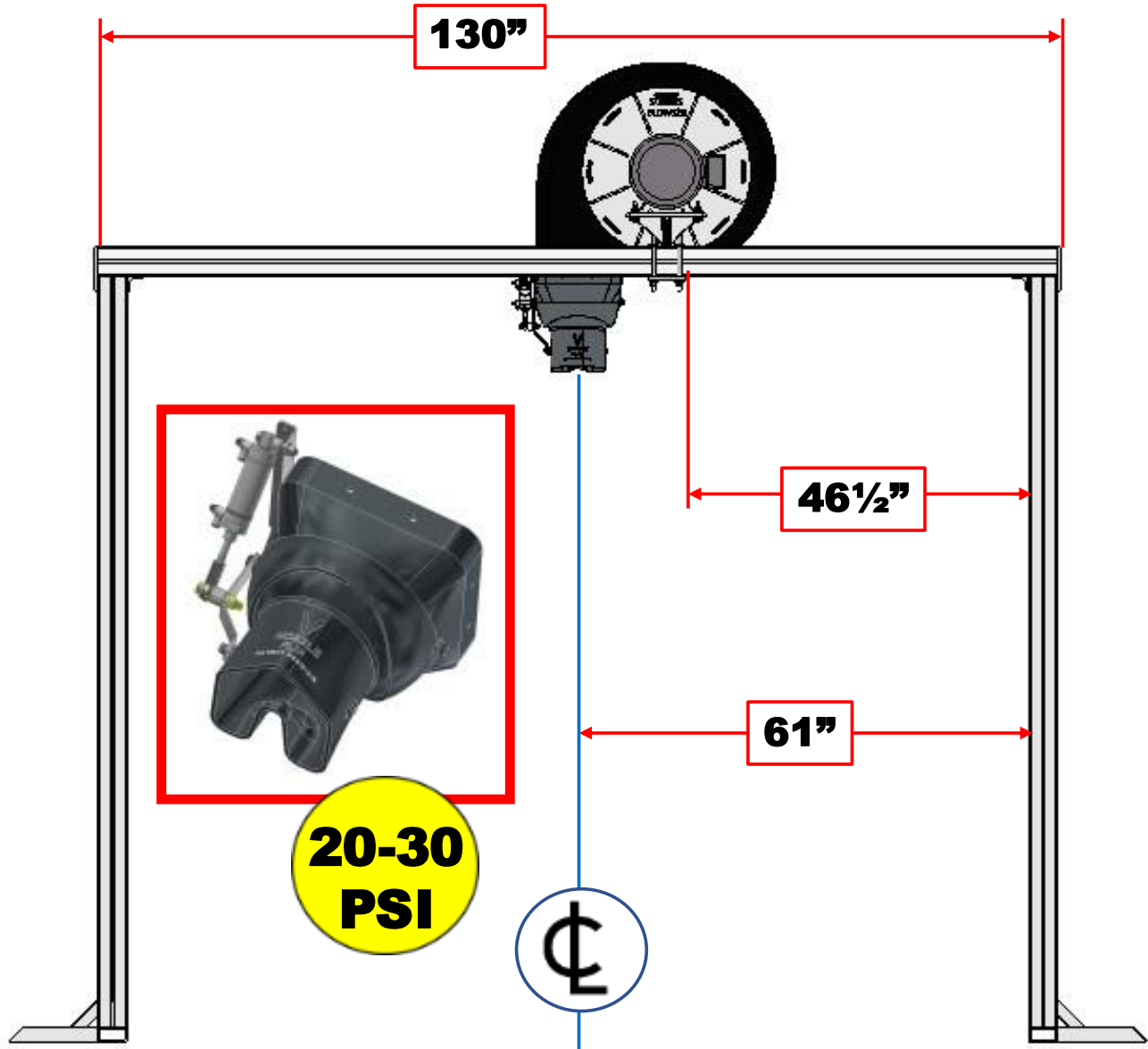

INSTALLATION DIMENSIONS

Two Blowers Half V-Nozzle

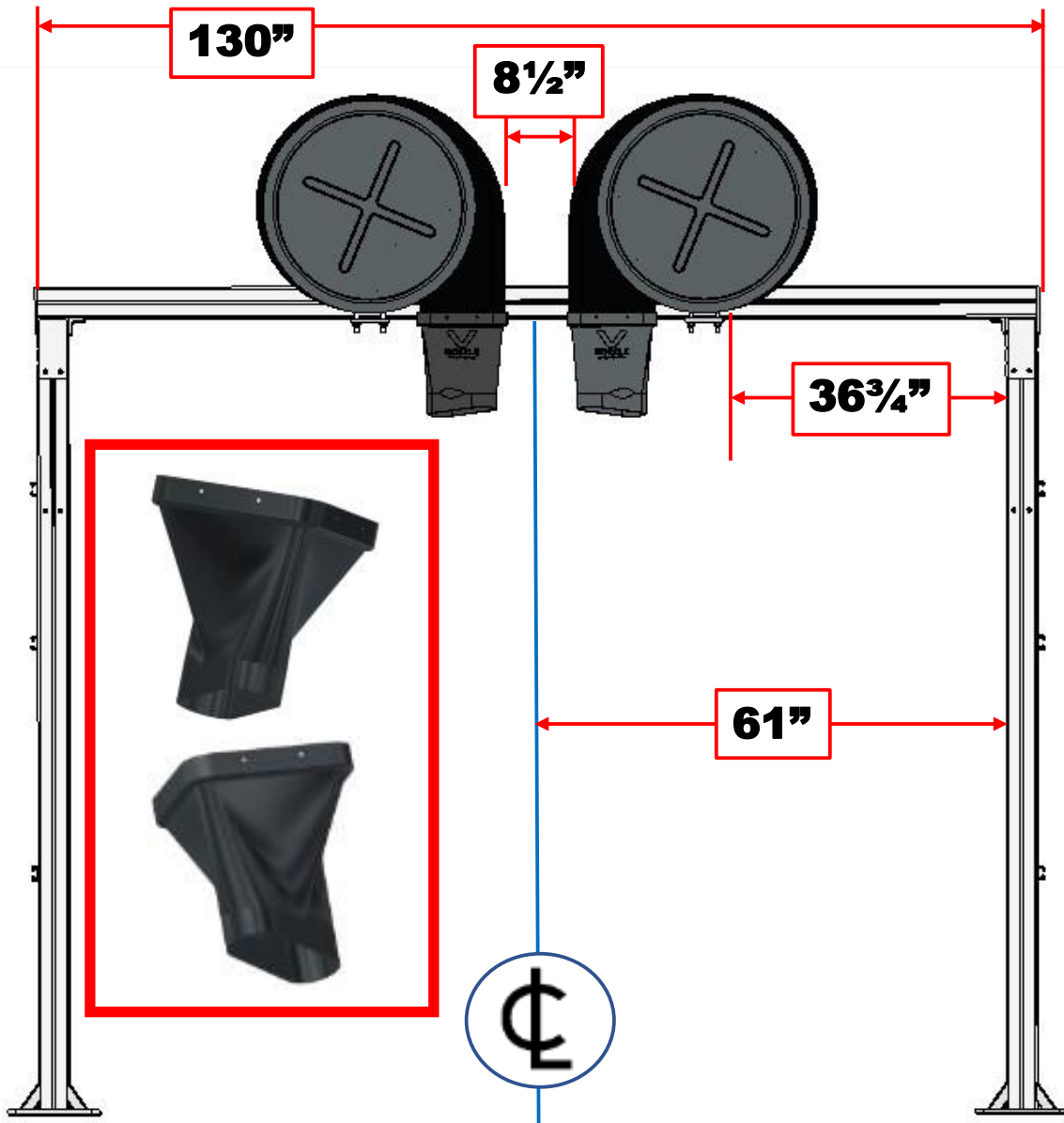

INSTALLATION DIMENSIONS

Two Blowers Double V-Nozzle

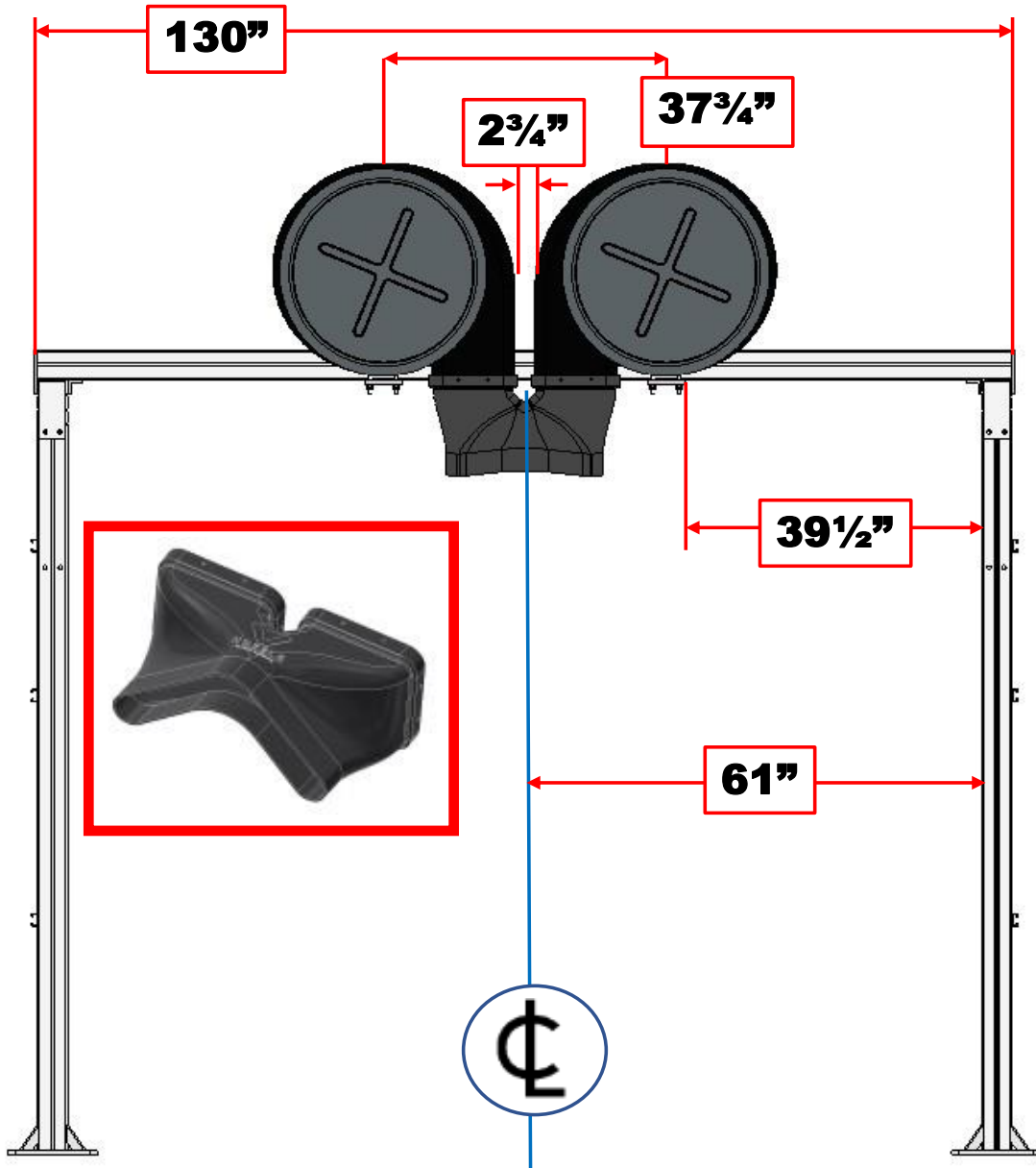

INSTALLATION OPTIONS

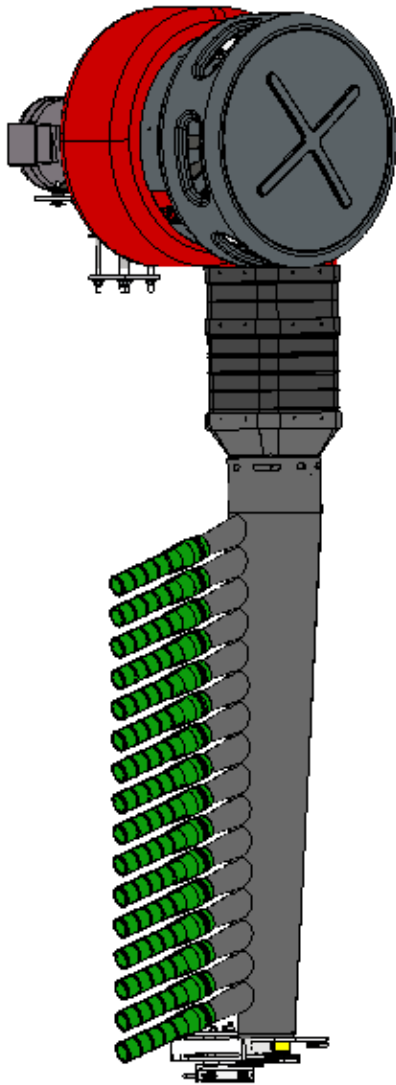

**8
Blowers
120HP**



**10
Blowers
150HP**



**13
Blowers
195HP**

INSTALLATION OPTIONS

Footprint Length	97" – 8 Blowers 172" – 10 Blowers 235" – 13 Blowers
Footprint Width	130" Beams <ul style="list-style-type: none"> • 138" – 8 Blowers • 154" – 10 to 13 Blowers 144" Beams <ul style="list-style-type: none"> • 152" – 8 Blowers • 168" – 10 to 13 Blowers
Unit Height	132"
Vehicle Clearance	90"

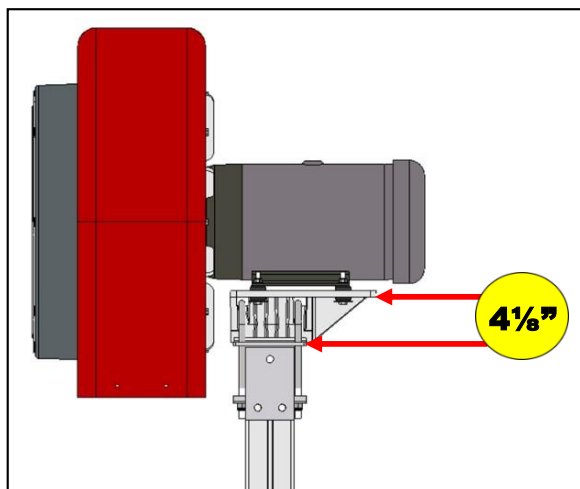

**DO NOT OVERTIGHTEN
U-BOLTS
MAX TORQUE: 57 ft-lb**

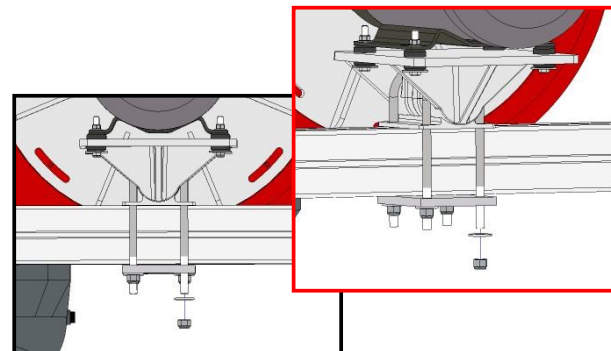

INSTALLATION BLOWER OPTIONS

ONLY USE These Options to Ensure Blower Optimization

BEAM INSTALL – MOTOR SIDE

Impeller Options

**DO NOT OVERTIGHTEN
U-BOLTS
MAX TORQUE: 57 ft-lb**

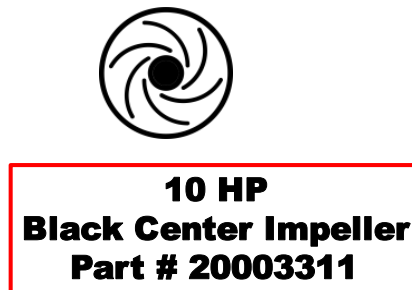
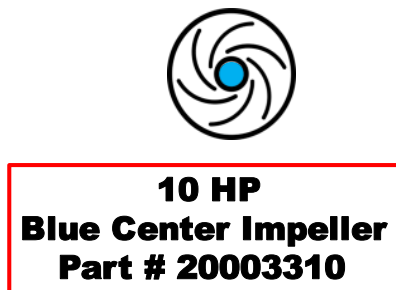
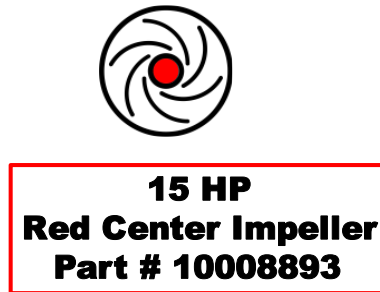
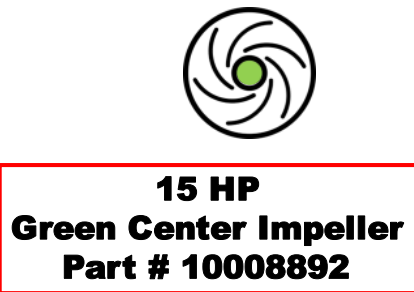
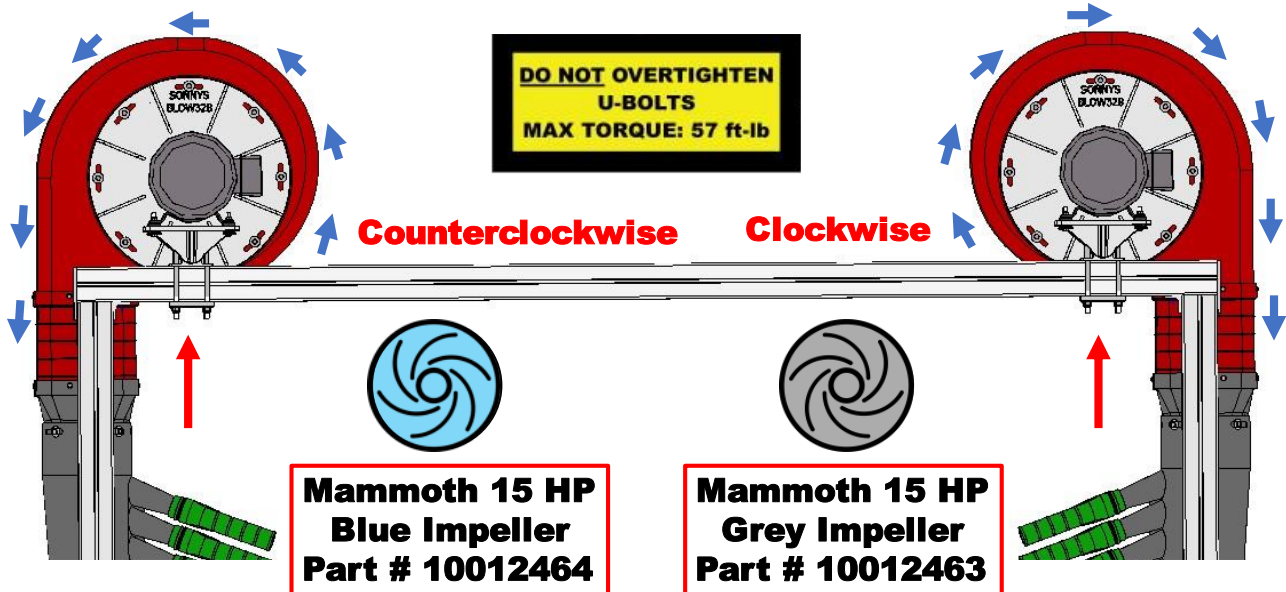

INSTALLATION BLOWER OPTIONS

ONLY USE These Options to Ensure Blower Optimization

LEG INSTALL – MOTOR SIDE

Impeller Options

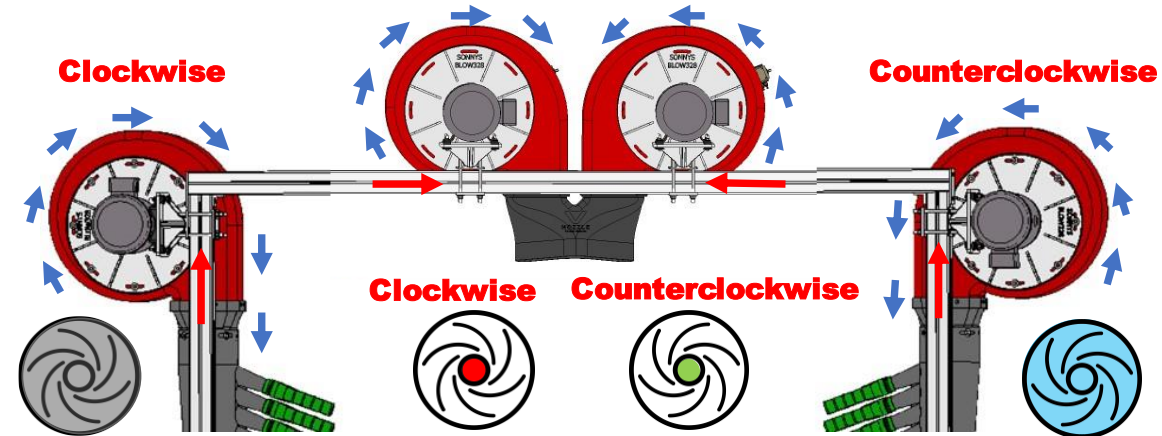

**Mammoth 15 HP
Grey Impeller
Part # 10012463**

**15 HP
Red
Center
Impeller
10008893**

**15 HP
Green
Center
Impeller
10008892**

**Mammoth 15 HP
Blue Impeller
Part # 10012464**

**15 HP Red
Center Impeller
Part # 10008893**

**10 HP
Black
Center
Impeller
20003311**

**10 HP
Blue
Center
Impeller
20003310**

**15 HP Green
Center Impeller
Part # 10008892**

**10 HP Black
Center Impeller
Part # 20003311**

**DO NOT OVERTIGHTEN
U-BOLTS
MAX TORQUE: 57 ft-lb**

**10 HP Blue
Center Impeller
Part # 20003310**

INSTALLATION ORDER

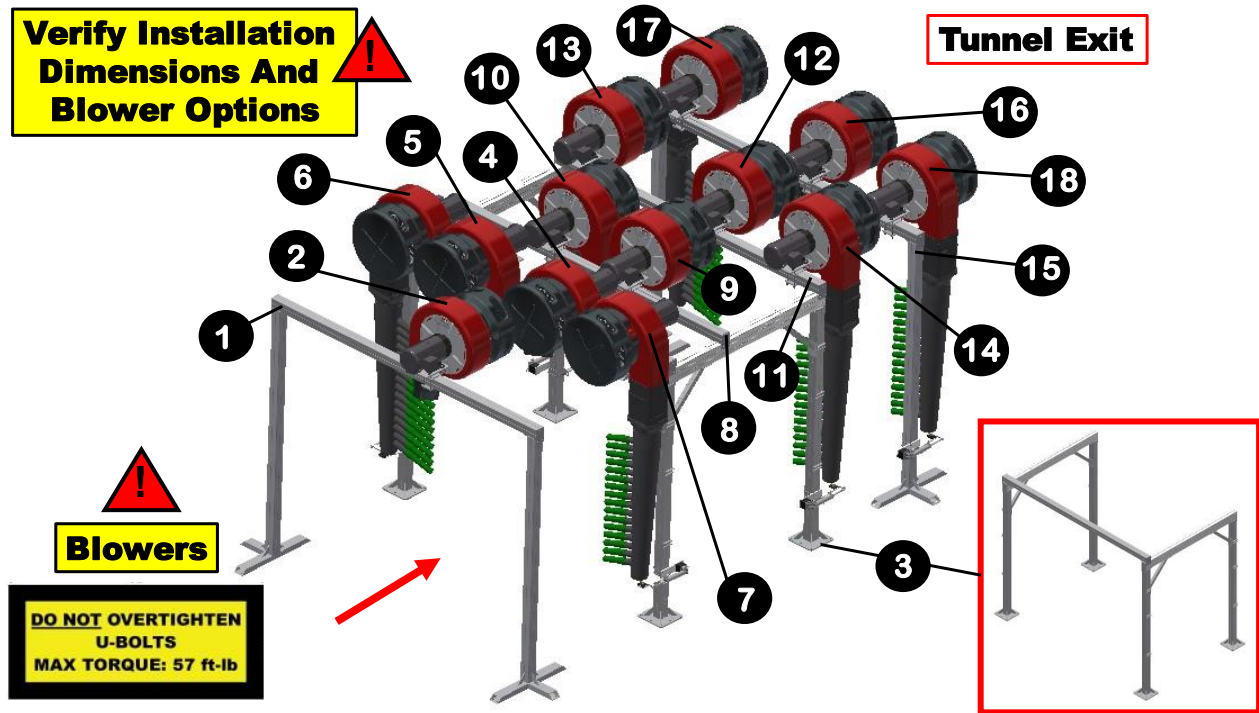

- 1. Install Complete Stand-Alone Frame and Tighten All Hardware**
- 2. Install Blower and Torque U-Bolts to 57 ft-lb**
- 3. Install Frame, Cross Beam and Tighten All Hardware**
- 4. 5. 6. & 7. Install Blowers and Torque U-Bolts to 57 ft-lb**
- 8. Install Cross Beam and Tighten All Hardware**
- 9. & 10. Install Blowers and Torque U-Bolts to 57 ft-lb**
- 11. Install Cross Beam and Tighten All Hardware**
- 12. 13. & 14. Install Blowers and Torque U-Bolts to 57 ft-lb**
- 15. Install Complete Stand-Alone Frame and Tighten All Hardware**
- 16. 17. & 18. Install Blowers and Torque U-Bolts to 57 ft-lb**

MAMMOTH & V-NOZZLES INSTALLATION OPTIONS

Verify Installation Dimensions And Blower Options



Tunnel Exit

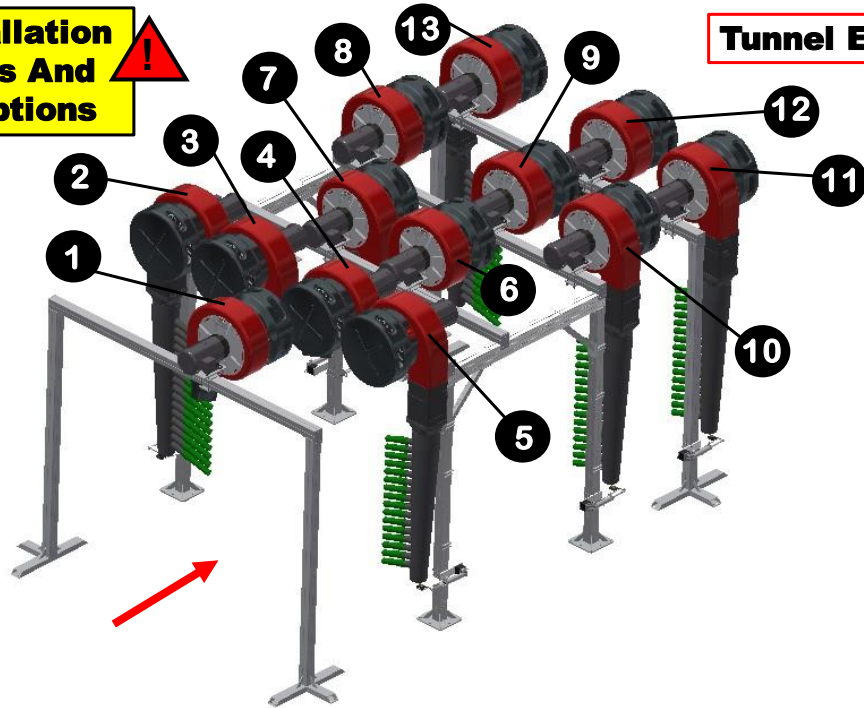

- 1. V-Nozzle**
- 2. Mammoth**
- 3. Half V-Nozzle Driver Side**
- 4. Half V-Nozzle Passenger Side**
- 5. Mammoth**
- 6. & 7. Double V-Nozzle**
- 8. Mammoth**
- 9. Flip V-Nozzle**
- 10. Mammoth**
- 11. Mammoth**
- 12. Flip V-Nozzle**
- 13. Mammoth**

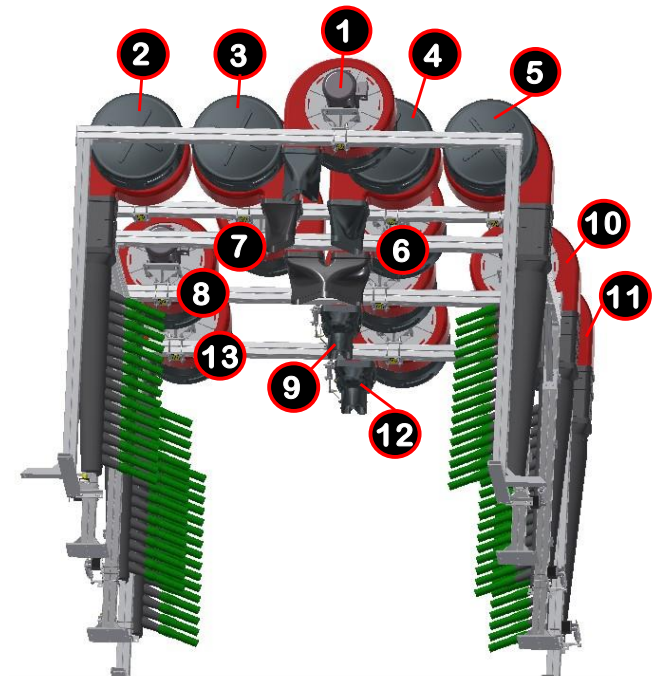

INSTALLATION INSTRUCTIONS

⚠ IMPORTANT: All parts and components **MUST** be installed by experienced and trained technicians. Safety wear is required for ALL personnel.

Work Force	Check	Installation Time	Check
2 Experienced and Trained Technicians	<input checked="" type="checkbox"/>	Frame Install 2 to 3 Hours Without Setbacks	<input checked="" type="checkbox"/>
2 Experienced and Trained Technicians	<input checked="" type="checkbox"/>	Blower Install 1 to 6 Hours Without Setbacks	<input checked="" type="checkbox"/>

⚠ DANGER: If Applicable, Always Shutoff All Power to Conveyor and Tunnel Before Starting Any Install or Repairs.

Determine where the **Blower Frame System** is to be installed (see [Installation Dimensions](#) for your location).

⚠ IMPORTANT: If the Equipment Installation Dimensions at the time of installation are NOT measured correctly, it may result in equipment damage and/or failure.

STAND-ALONE FRAME INSTALLATION

Reference Blower Installation Section

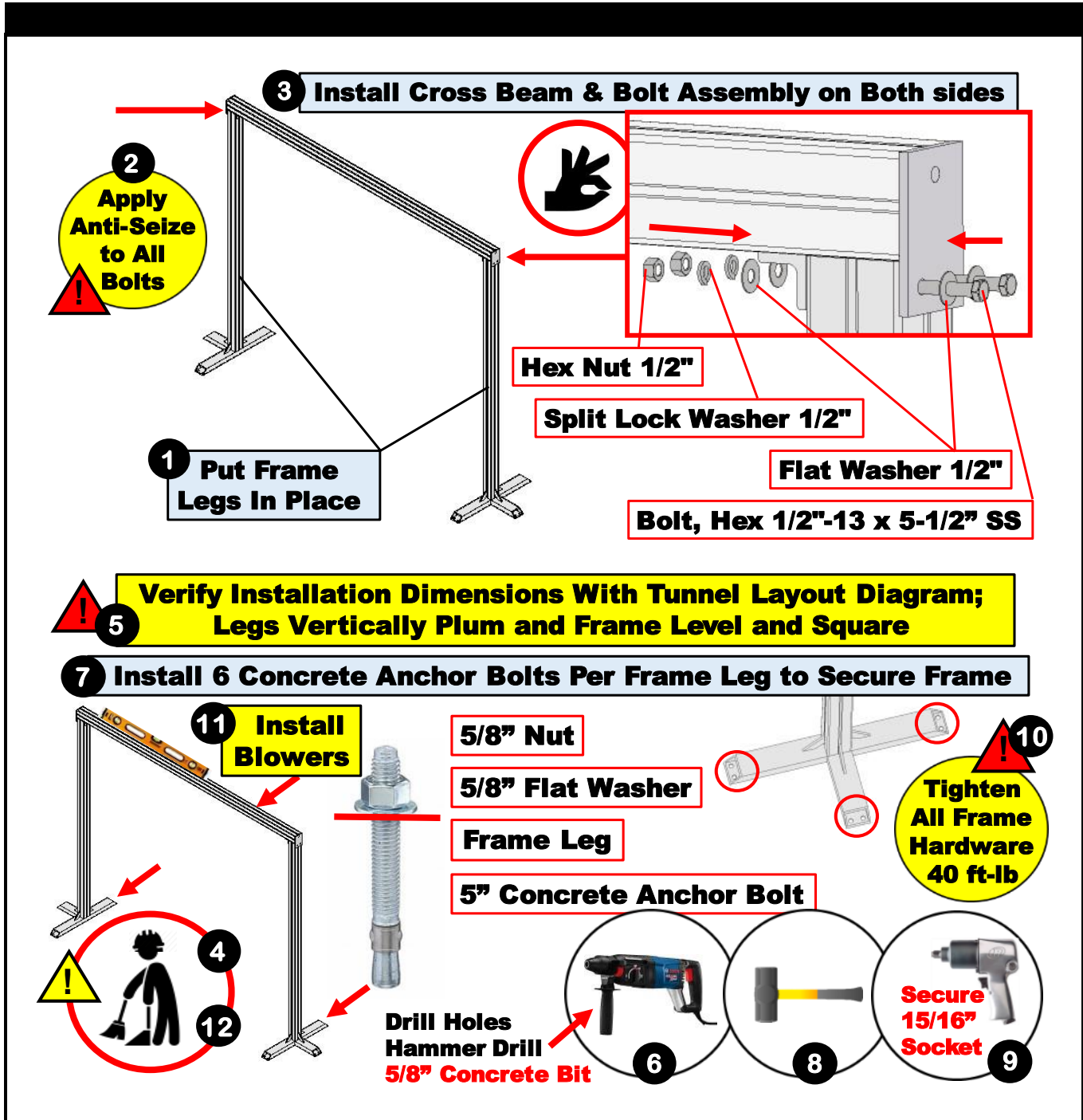

MAIN FRAME INSTALLATION

Reference Blower Installation Section

3 Install Cross Beam, 4 Braces & Bolt Assemblies

1 Put Frame Legs In Place

2 Apply Anti-Seize to All Bolts

5 Verify Installation Dimensions With Tunnel Layout Diagram; Legs Vertically Plum and Frame Level and Square

7 Install 4 Concrete Anchor Bolts Per Frame Leg to Secure Frame

11 Install Blowers

4

12

6

8

9

10 Tighten All Frame Hardware 40 ft-lb

Hex Nut 1/2"

Split Lock Washer 1/2"

Flat Washer 1/2"

Hex Nut 1/2"

Bolt, Hex 1/2"-13 x 5-1/2"

Bolt, Hex 1/2"-13 x 8"

5/8" Nut

5/8" Flat Washer

Frame Leg

5" Concrete Anchor Bolt

Drill Holes

Hammer Drill

5/8" Concrete Bit

Secure 15/16" Socket

MAIN FRAME INSTALLATION

Reference Blower Installation Section

14 Install Cross Beam & Bolt Assemblies On Both Sides

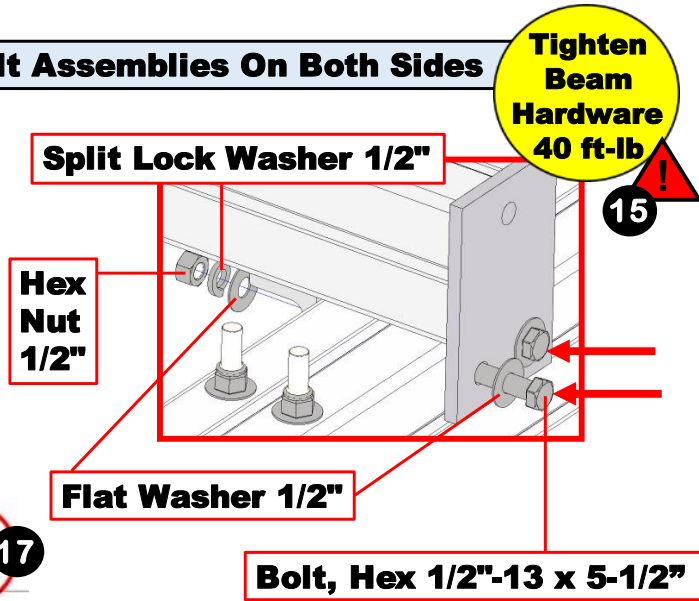
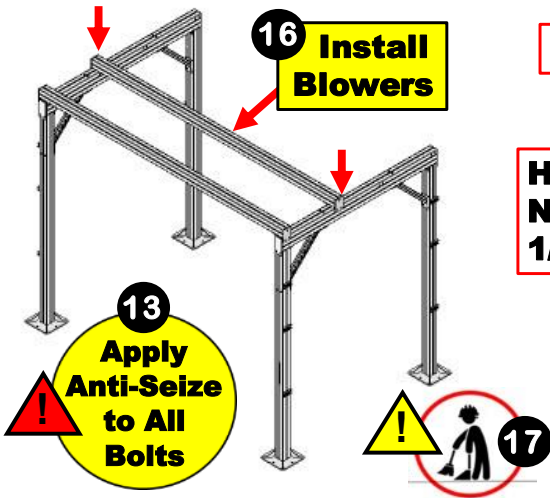

19 Install Cross Beam & Bolt Assemblies On Both Sides

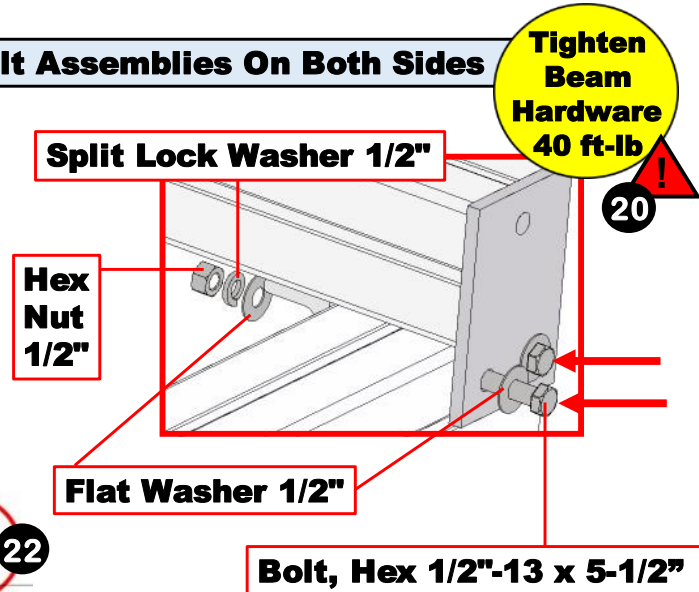
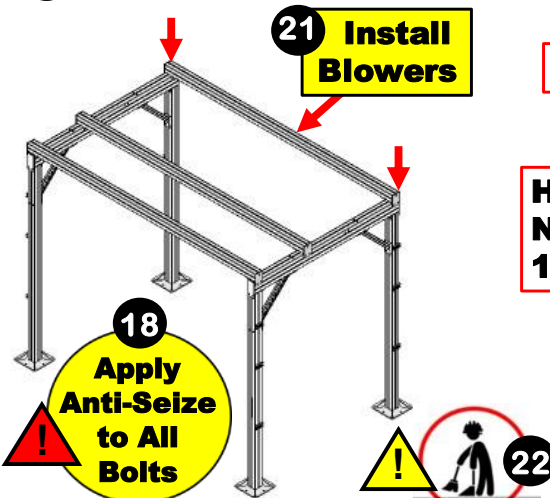

BLOWER INSTALLATION – LEFT SIDE ON BEAM

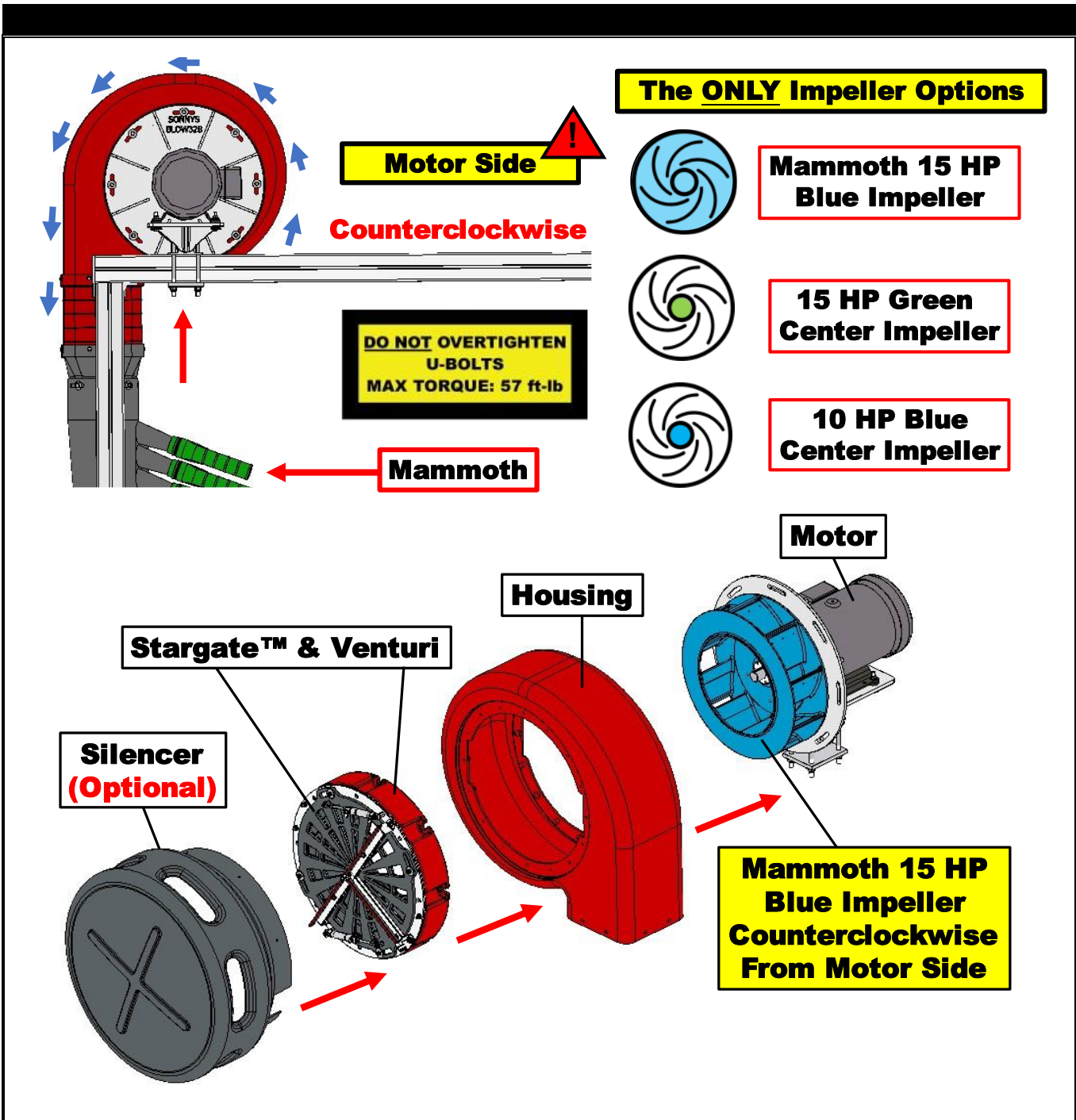

BLOWER INSTALLATION – LEFT SIDE ON BEAM

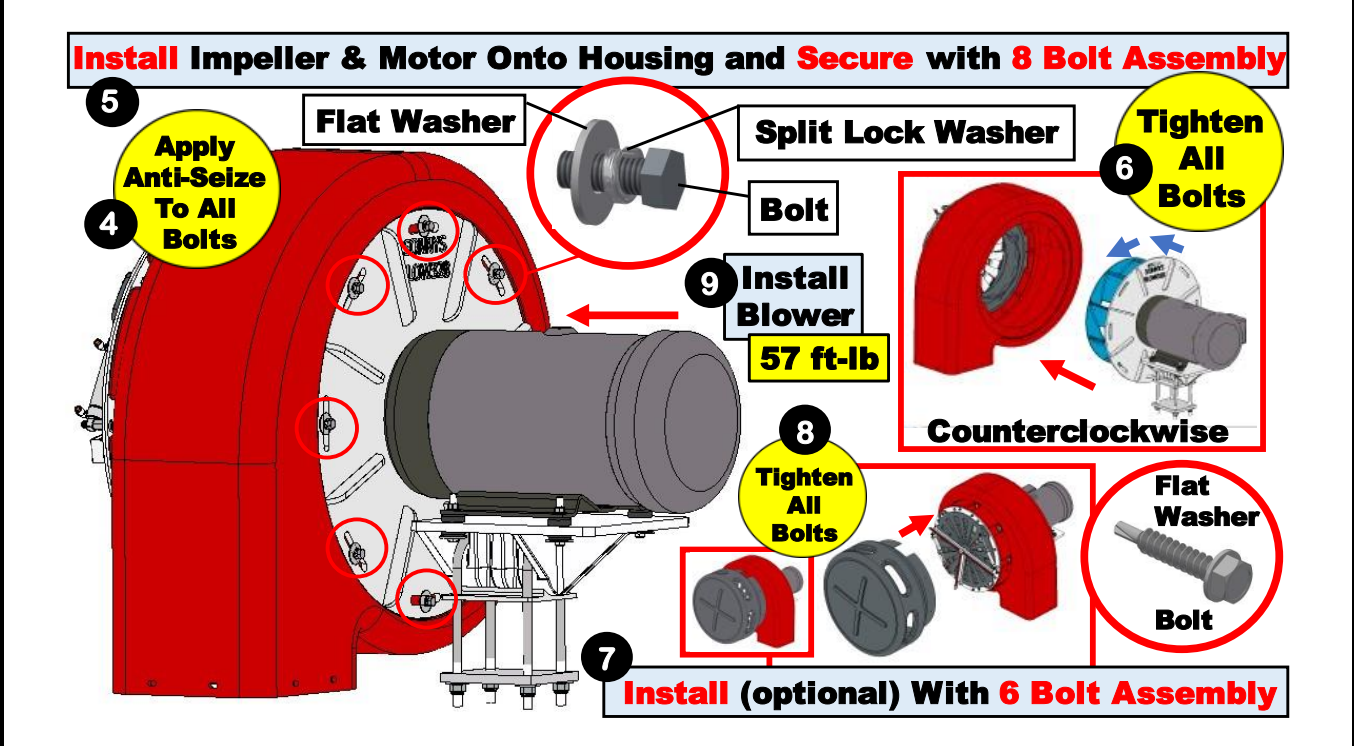
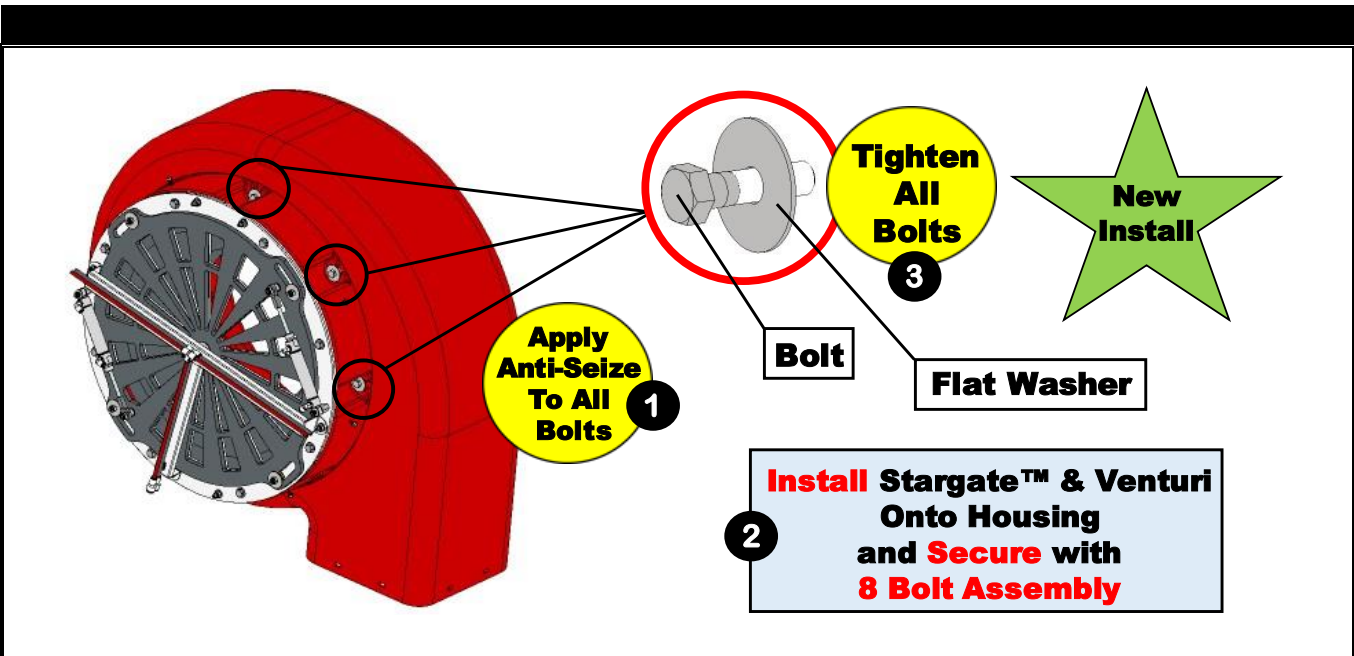

BLOWER INSTALLATION – RIGHT SIDE ON BEAM

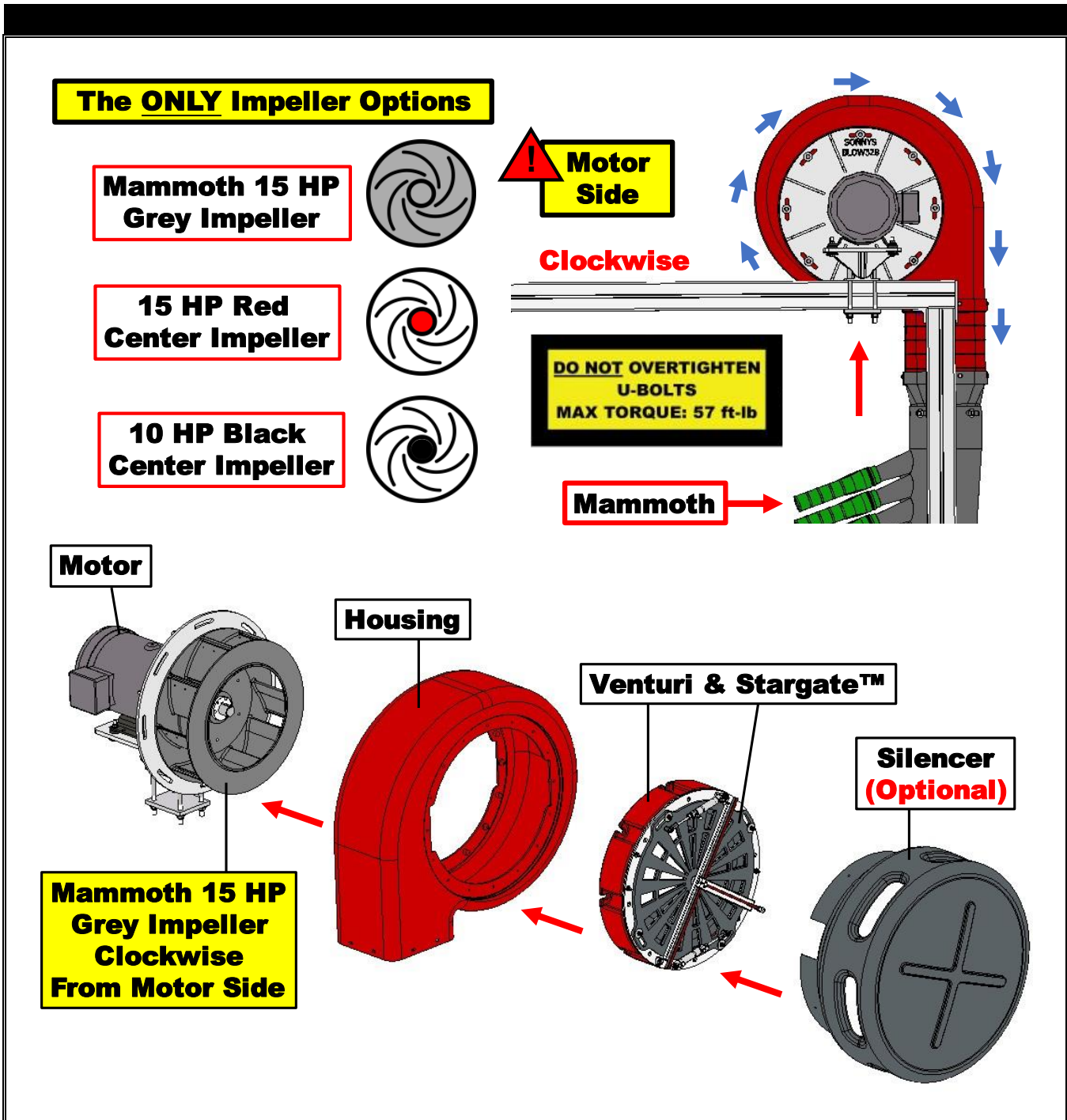

BLOWER INSTALLATION – RIGHT SIDE ON BEAM

New Install

3 Tighten All Bolts

Flat Washer

Bolt

1 Apply Anti-Seize To All Bolts

2 Install Stargate™ & Venturi Onto Housing and Secure with 8 Bolt Assembly

5 Tighten All Bolts

Split Lock Washer

Flat Washer

Bolt

4 Apply Anti-Seize To All Bolts

6 Tighten All Bolts

9 Install Blower 57 ft-lb

8 Tighten All Bolts

Flat Washer

Bolt

7 Install (optional) With 6 Bolt Assembly

Clockwise

BLOWER INSTALLATION – LEFT SIDE ON LEG

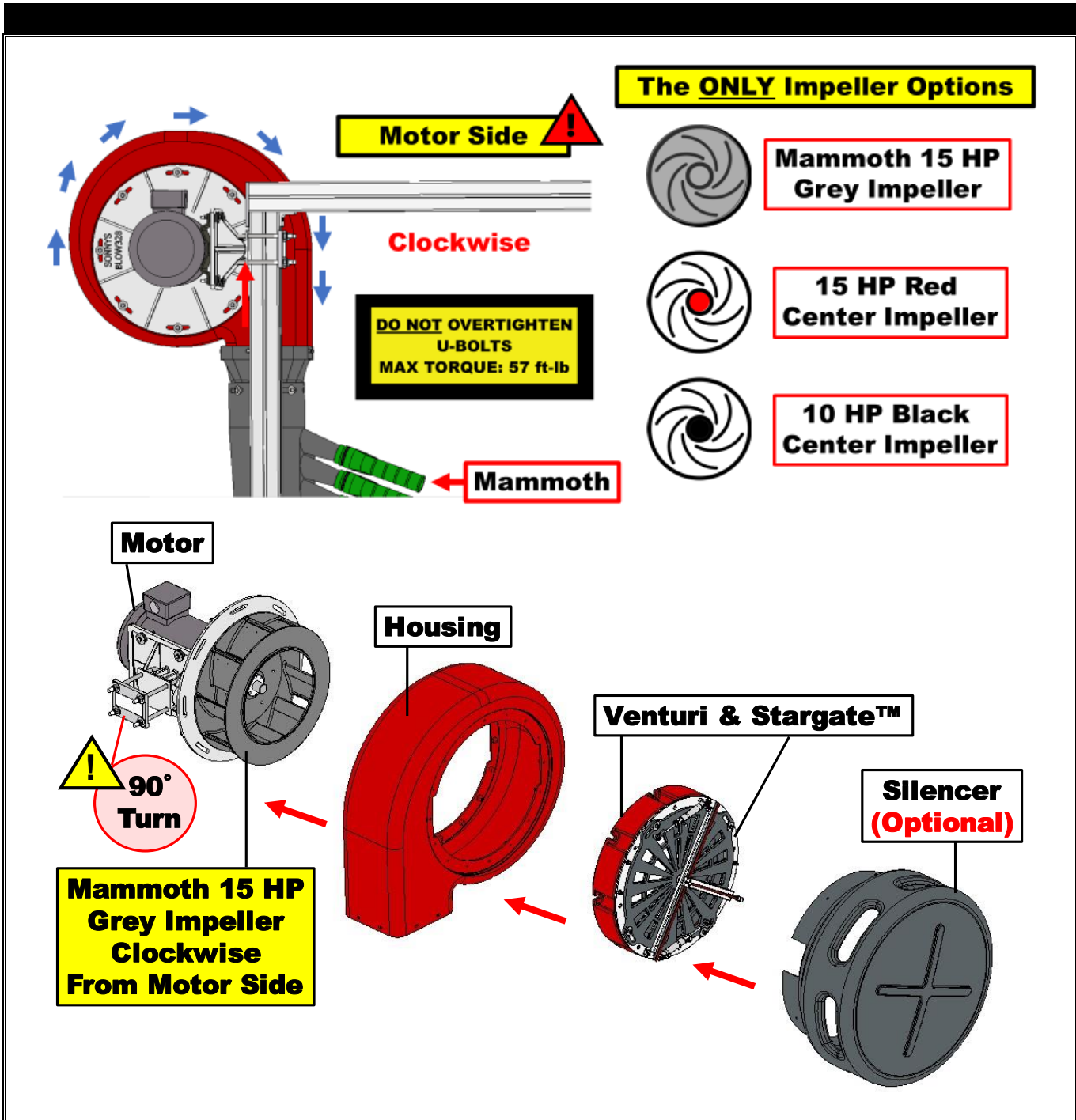

BLOWER INSTALLATION – LEFT SIDE ON LEG

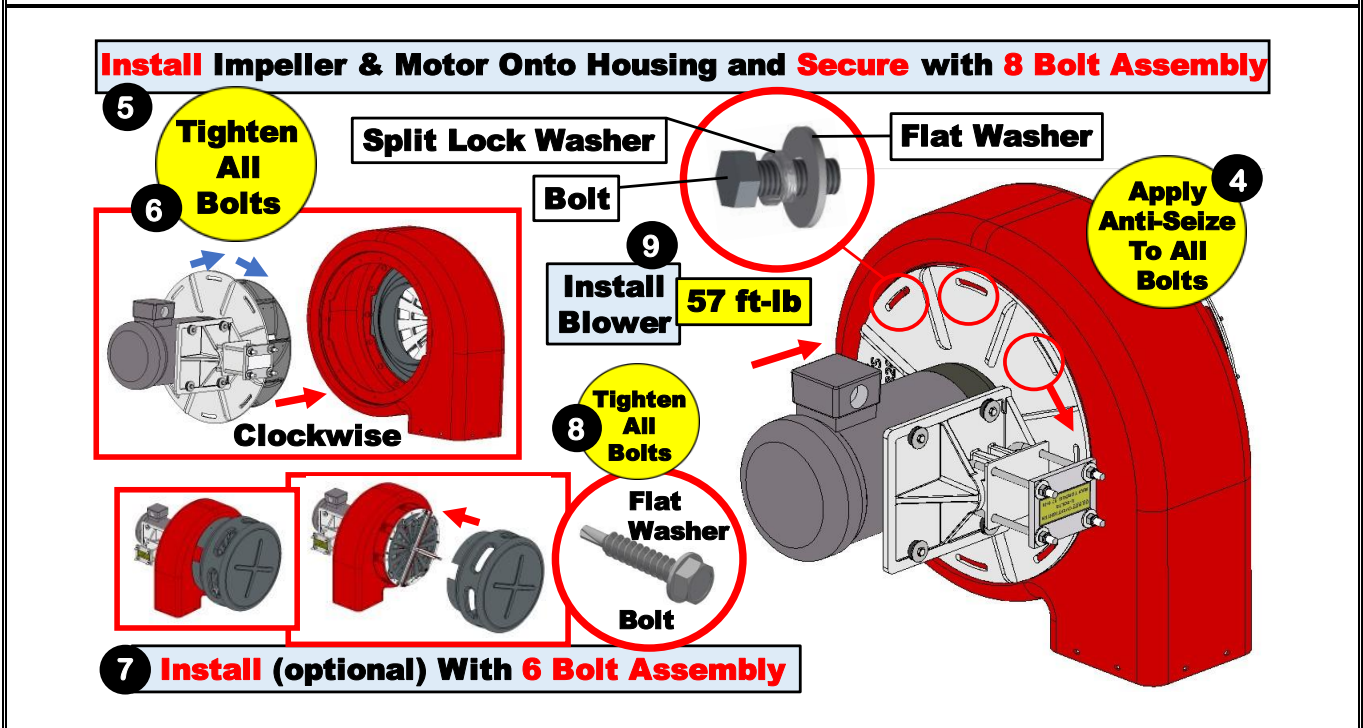
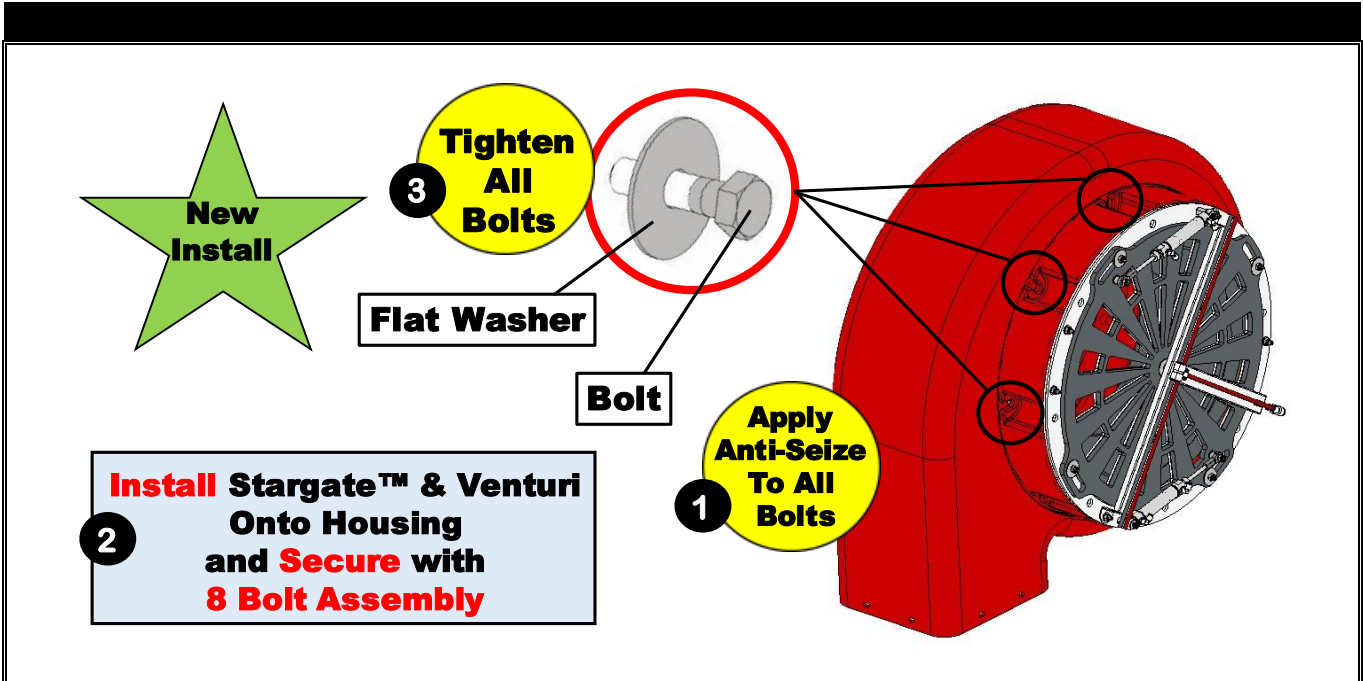

BLOWER INSTALLATION – RIGHT SIDE ON LEG

The ONLY Impeller Options

Mammoth 15 HP Blue Impeller



15 HP Green Center Impeller



10 HP Blue Center Impeller



Motor Side

Counterclockwise

**DO NOT OVERTIGHTEN U-BOLTS
MAX TORQUE: 57 ft-lb**

Mammoth

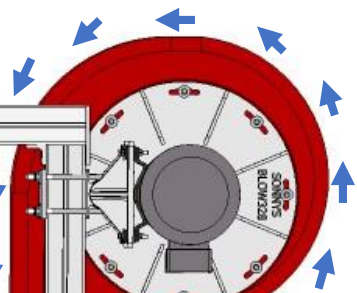

Stargate™ & Venturi

Silencer (Optional)

Housing

Motor

90° Turn

**Mammoth 15 HP Blue Impeller
Counterclockwise
From Motor Side**

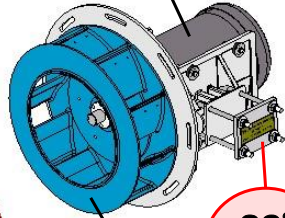
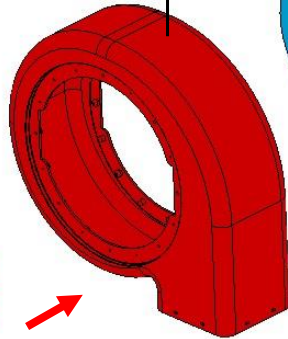
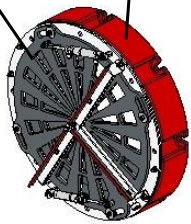
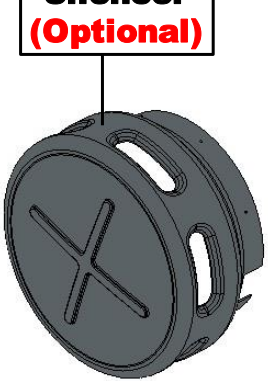

BLOWER INSTALLATION – RIGHT SIDE ON LEG

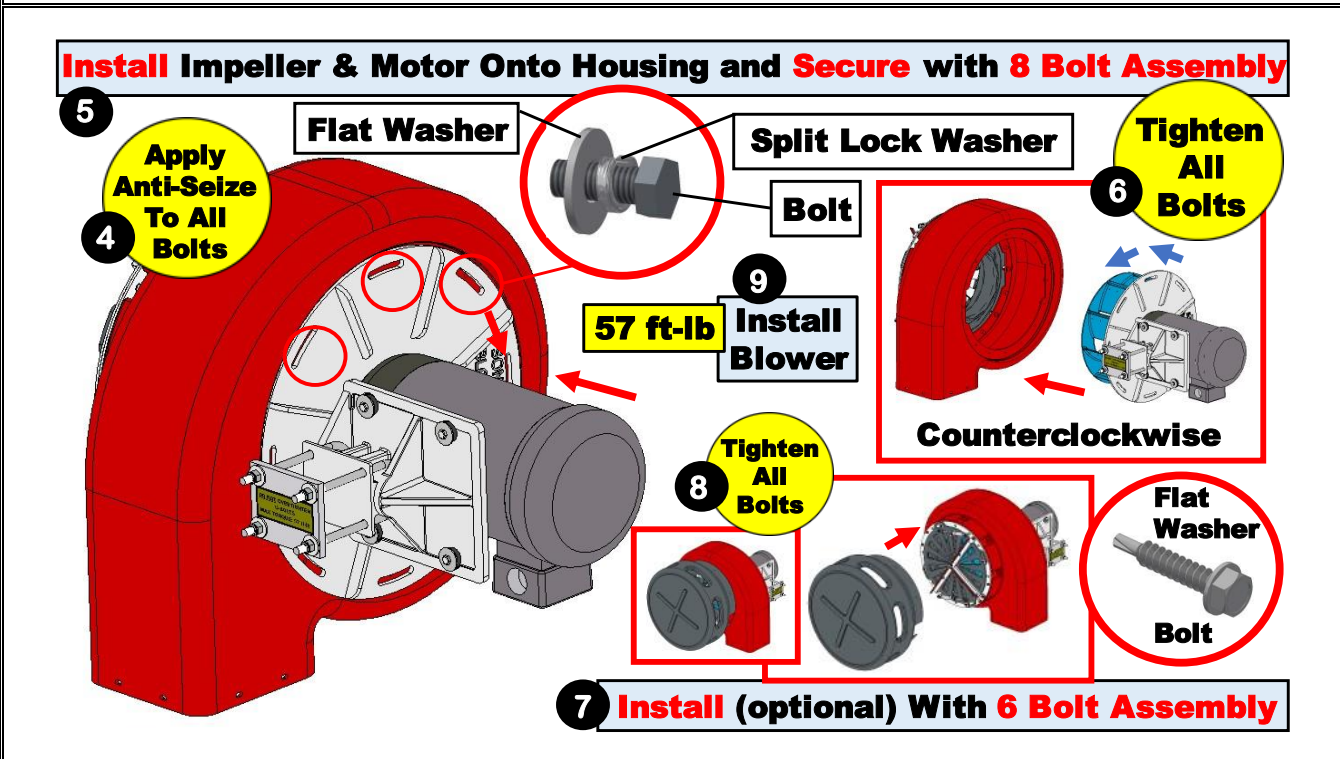
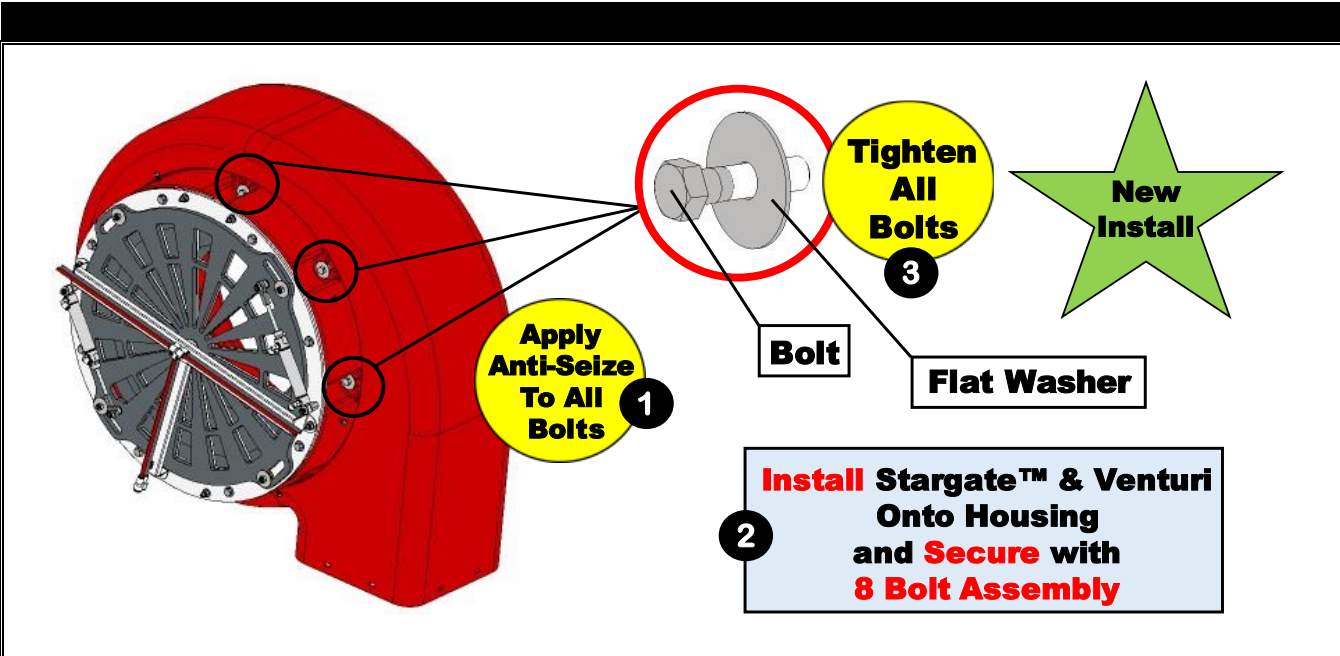

BLOWER INSTALLATION – ON BEAM CENTER LEFT

**DO NOT OVERTIGHTEN U-BOLTS
MAX TORQUE: 57 ft-lb**

The ONLY Impeller Options

Motor Side

15 HP Red Center Impeller

10 HP Black Center Impeller

Motor

Housing

Venturi & Stargate™

Silencer (Optional)

15 HP Red Center Impeller Clockwise From Motor Side

BLOWER INSTALLATION – ON BEAM CENTER LEFT

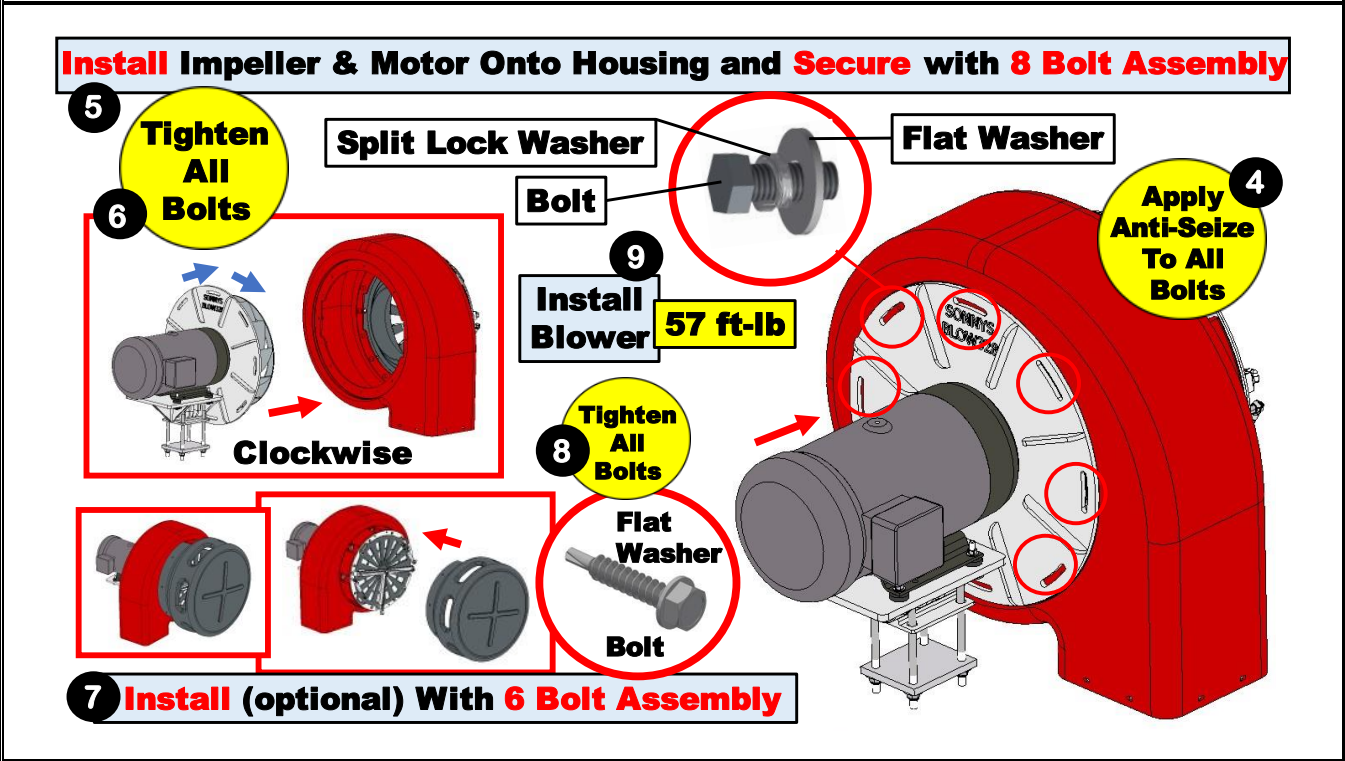
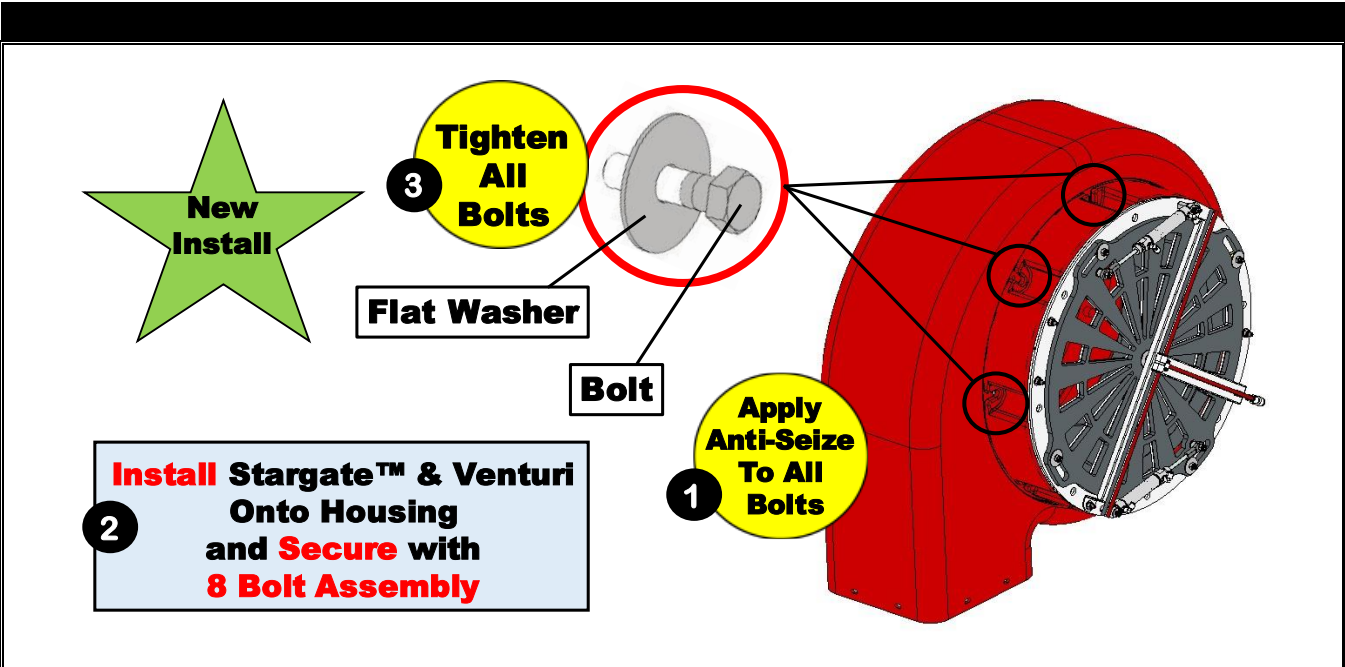

BLOWER INSTALLATION – ON BEAM CENTER RIGHT

The ONLY Impeller Options

Motor Side

15 HP Green Center Impeller

10 HP Blue Center Impeller

Counterclockwise

**DO NOT OVERTIGHTEN U-BOLTS
MAX TORQUE: 57 ft-lb**

Stargate™ & Venturi

Silencer (Optional)

Housing

Motor

**15 HP Green Center Impeller
Counterclockwise
From Motor Side**

© 2023 SONNY'S The CarWash Factory®. All Rights Reserved.

SonnysDirect.com

This document is confidential and proprietary to SONNY'S and cannot be used, disclosed, or published without prior written consent. Content, prices, and availability subject to change without notice. All brand names, trademarks or registered trademarks are the property of their respective owners.

Manual-O, Blower Frame System – Part # 10013905 - J

Page 46 of 77

BLOWER INSTALLATION – ON BEAM CENTER RIGHT

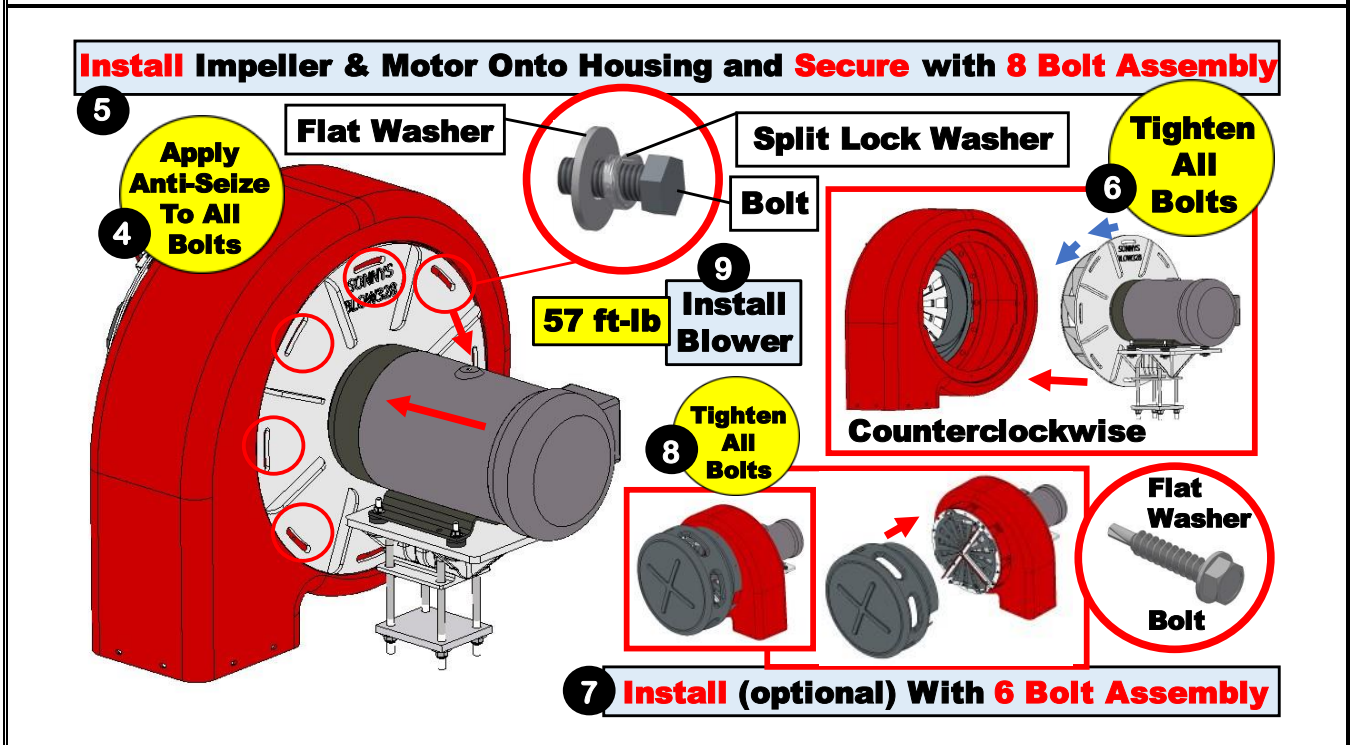
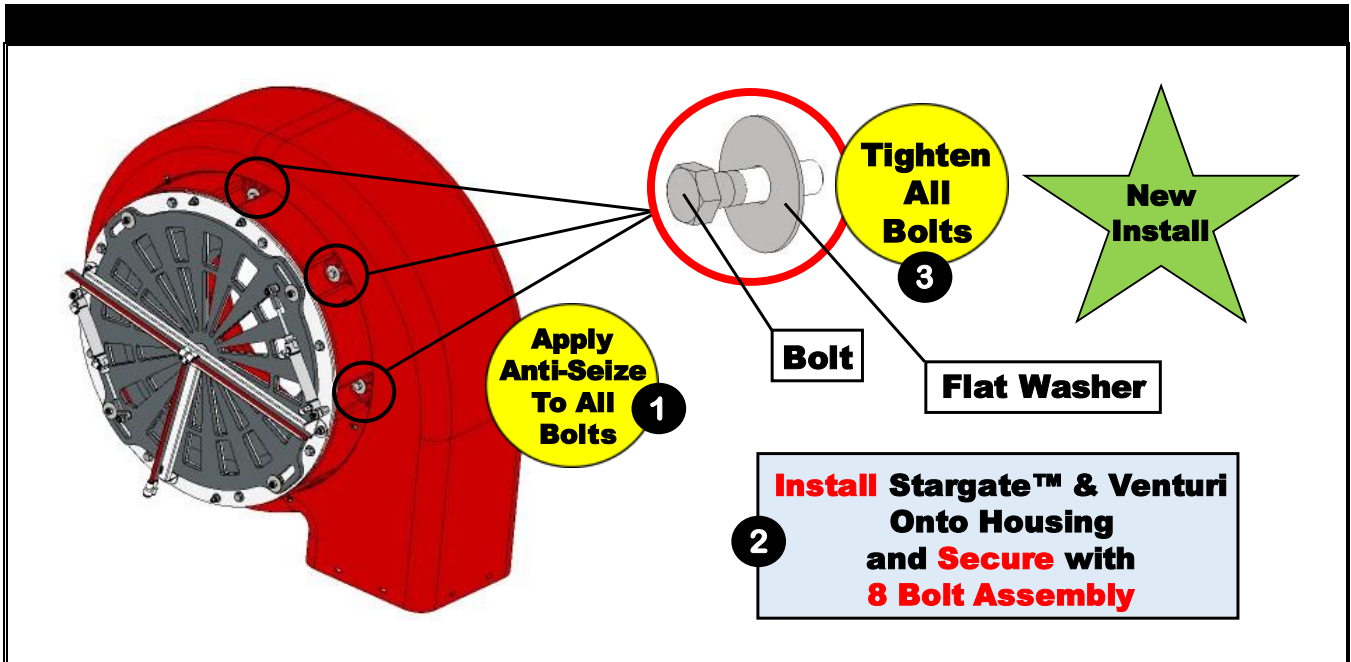

BLOWER INSTALLATION – ONTO FRAME

2 Verify Installation Dimensions and Install Blowers Onto Frame

3 Install Hardware

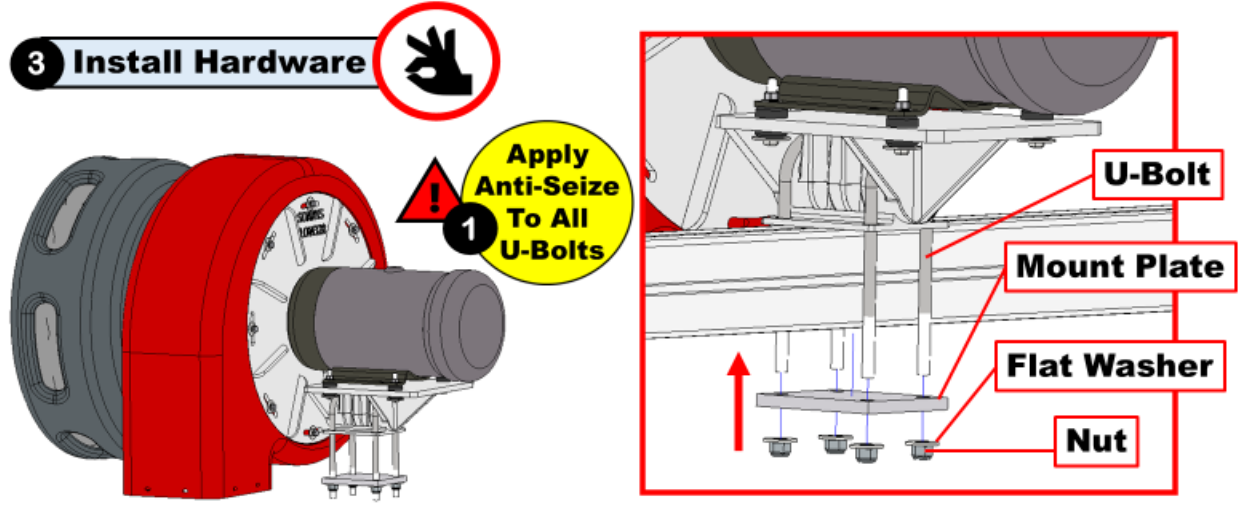

OR

2 Verify Installation Dimensions and Install Blowers Onto Frame

3 Install Hardware

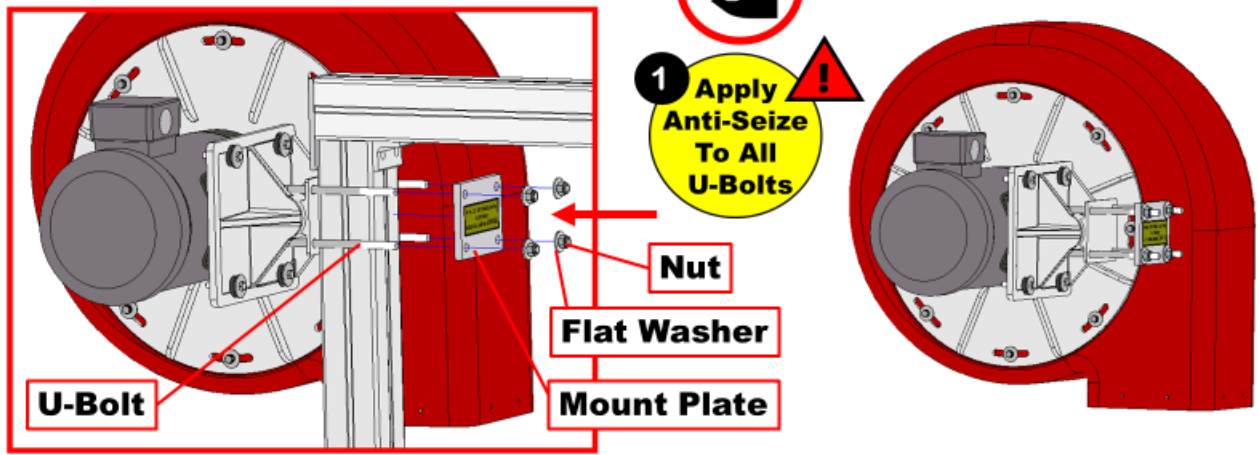

BLOWER INSTALLATION – ONTO FRAME

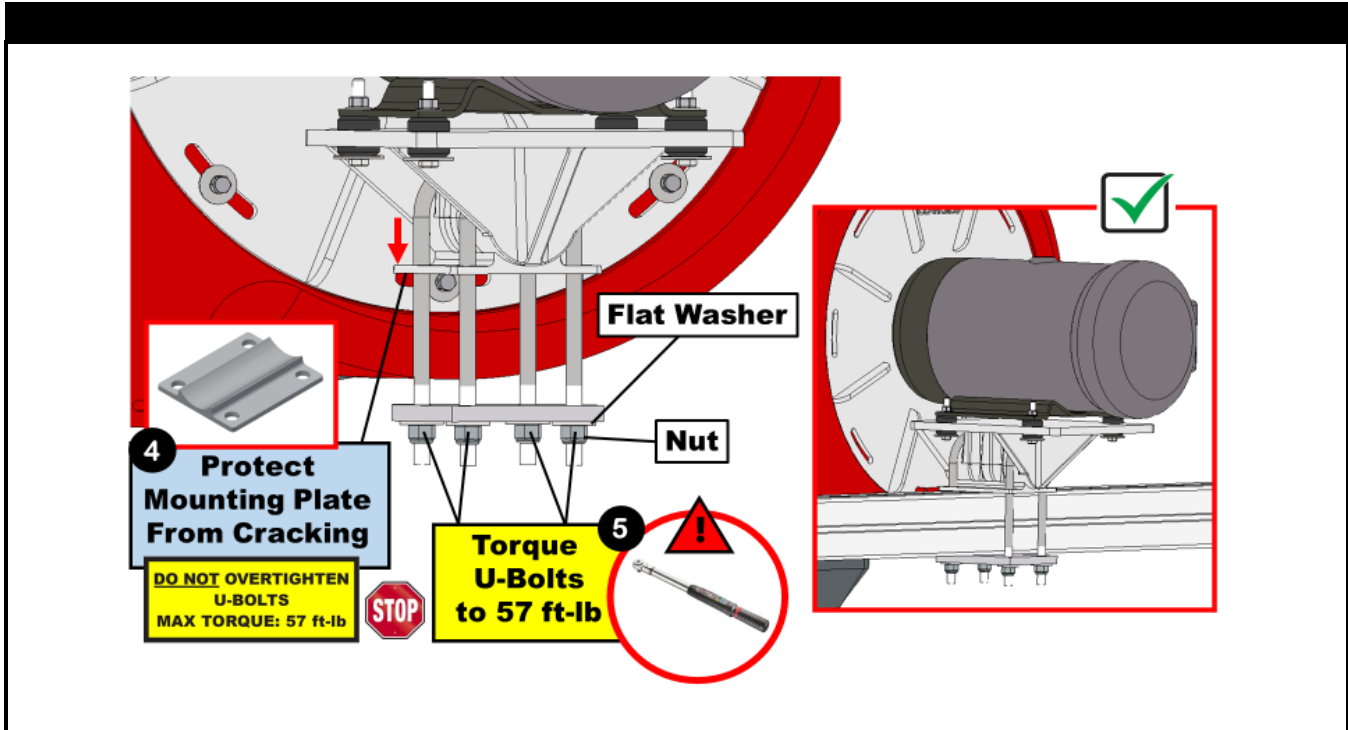

OR

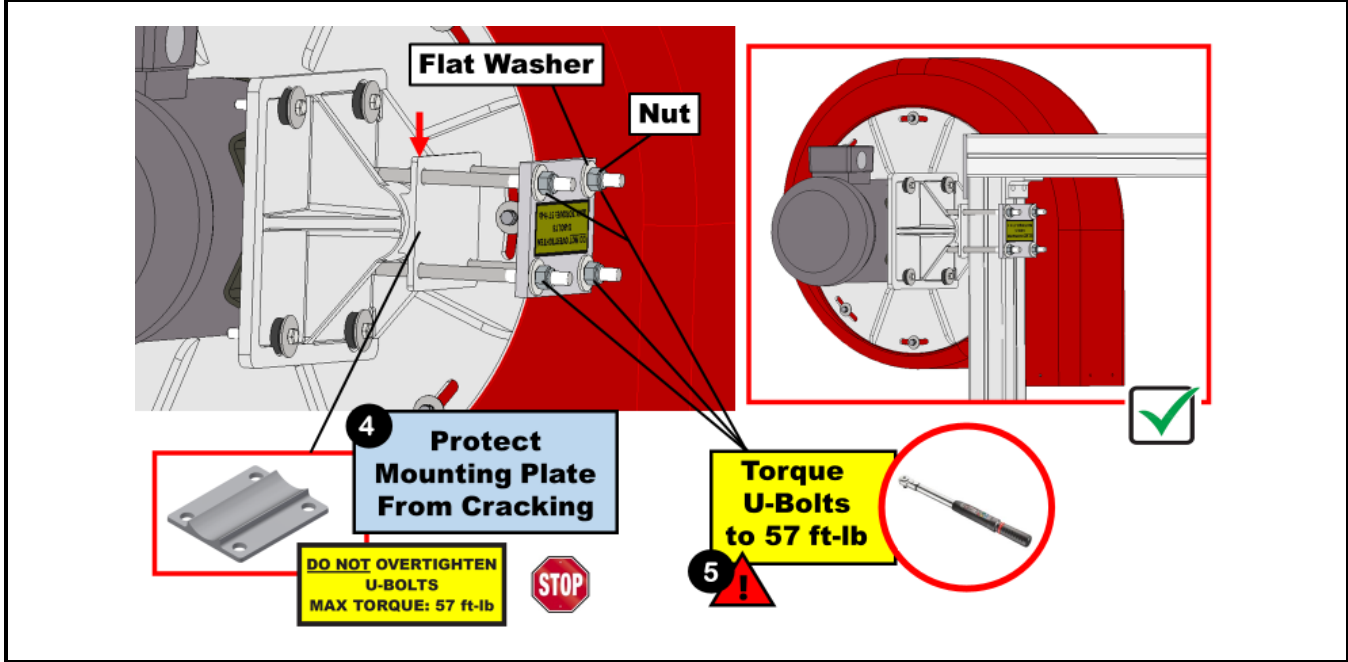

MAMMOTH INSTALLATION

MAMMOTH INSTALLATION

2 Install Attachments

Install 2, To Make Mammoth Longer Or Cut Segments To Make Shorter



Blower Installed On Beam

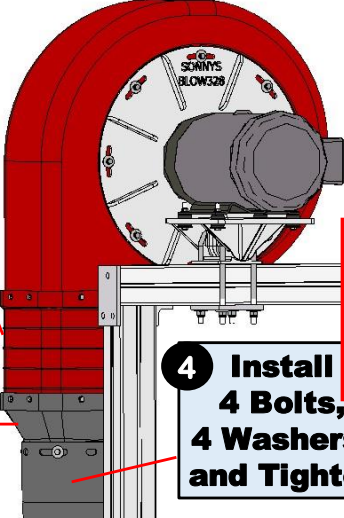

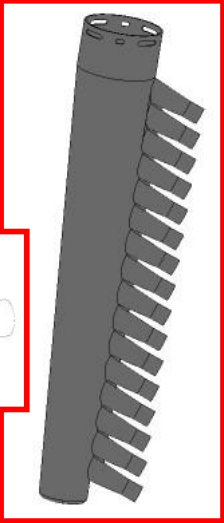

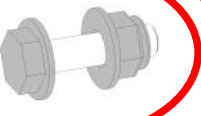

3 Install 8 Bolts, 16 Washers, 8 Nuts & Tighten

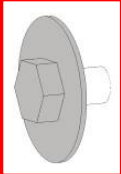

4 Install 4 Bolts, 4 Washers, and Tighten



1 Apply Anti-Seize To All Bolts



OR

2 Install Attachments

Install 2, To Make Mammoth Longer Or Cut Segments To Make Shorter



Blower Installed On Leg

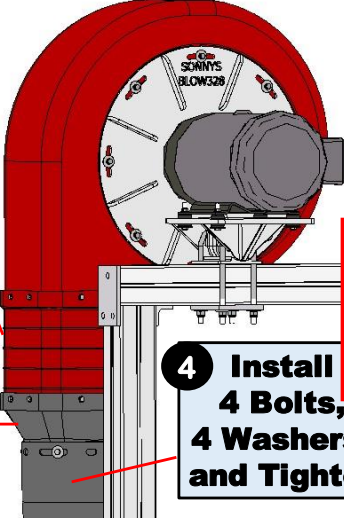

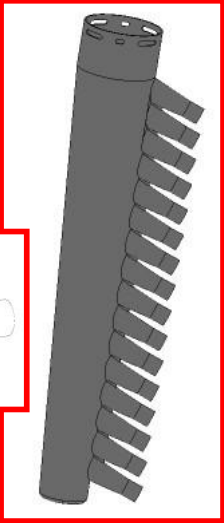

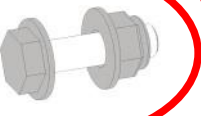

3 Install 8 Bolts, 16 Washers, 8 Nuts & Tighten

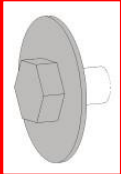

4 Install 4 Bolts, 4 Washers, and Tighten



1 Apply Anti-Seize To All Bolts



MAMMOTH INSTALLATION

5 Install 16 Trunks 12" Or 18" Each

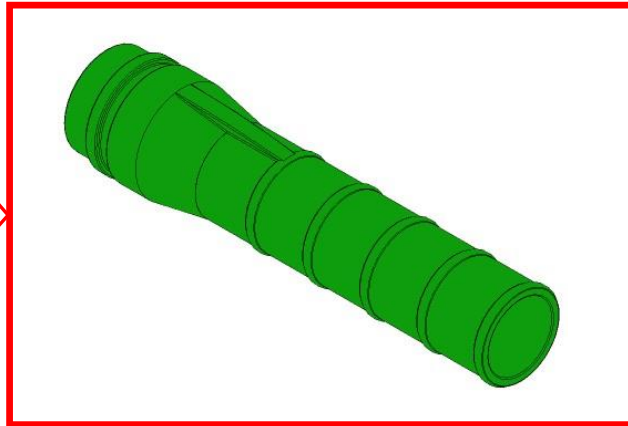
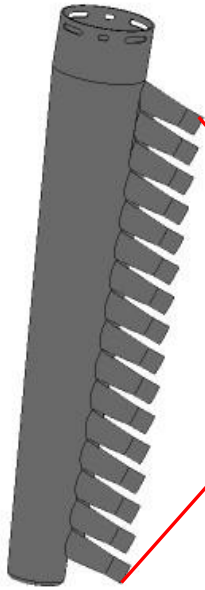

6 Secure All 16 Trunks With Zip Ties

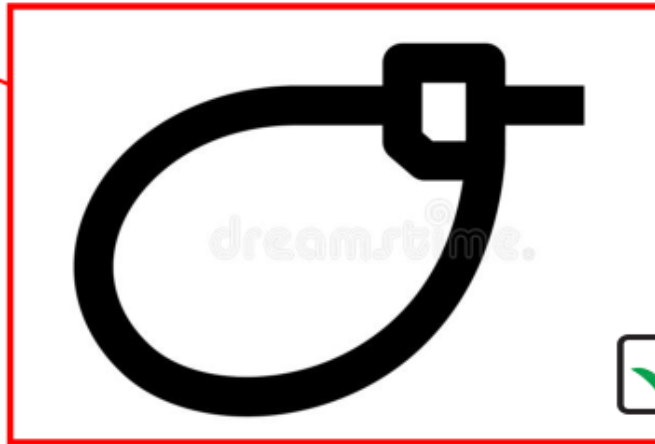
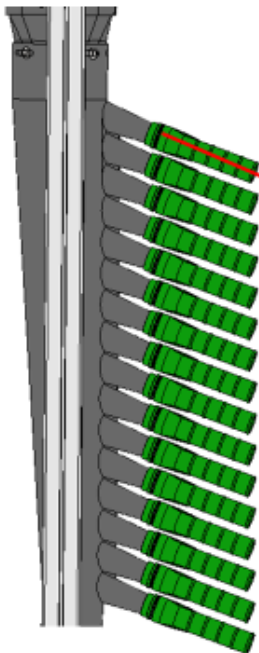

MAMMOTH INSTALLATION

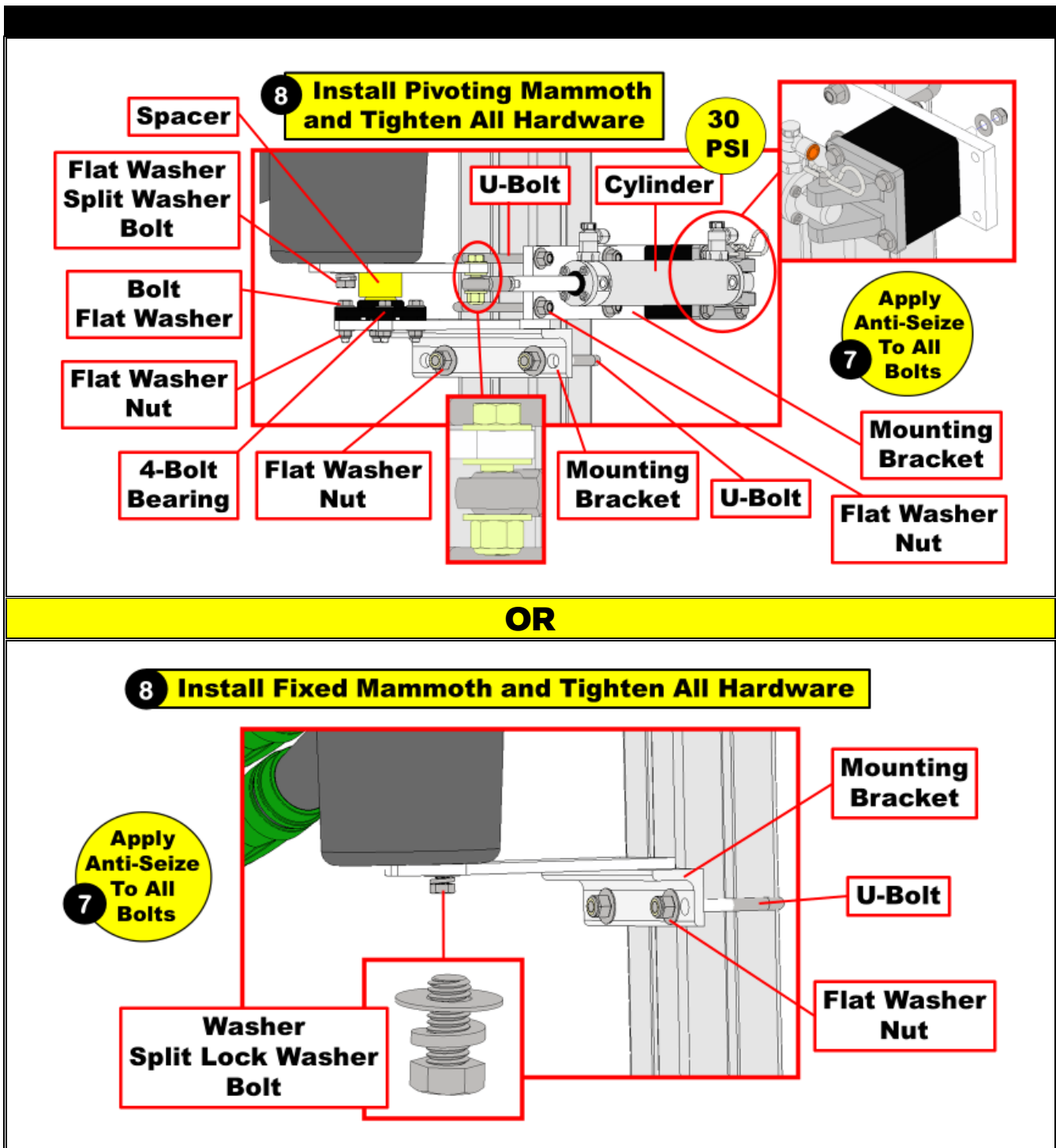

V-NOZZLE INSTALLATION

1 Apply Anti-Seize To All Bolts

2 Install V-Nozzles - On Center Beam Blowers, Tighten Bolts and Hardware
Verify With V-Nozzle Installation Options Section

3 

Single V-Nozzle **8**

Passenger Side Half V-Nozzle **8**

Driver Side Half V-Nozzle **8**

Flip V-Nozzle **8**

Double V-Nozzle **16**

20-30 PSI

ON Center Beams 





MAINTENANCE

⚠ IMPORTANT: FOR THE FIRST MONTH OF OPERATION CHECK ALL HARDWARE AND FITTINGS FOR TIGHTNESS EACH WEEK!

⚠ WARNING: Make sure the proper Chemistry (Brush Lubrication) is being used in the Car Wash Tunnel to prevent vehicle and equipment damage.



DAILY

- Check each producer for proper operation, listening for any unusual noises and correct the cause of any unusual vibration.
- Remove any debris from the air inlet screen on the air producers.
- Check the optional top oscillator or flip nozzle for proper operation.
- Wipe or wash down blower silencers, blower housings, and nozzles.
- Check nozzle outlets and blower silencer for debris or obstructions.



MONTHLY

- Inspect all hardware and fittings for tightness.
- Thoroughly clean the framework, blower silencers, blower housings and each impeller of dirt and debris.
- Check bolted connections to ensure they are tight.
- Check for damaged blower silencers.



ANNUALLY

- Measure and Record Full Load Amp Readings.
- Measure and record, full load current readings from each of the three legs of each of the three phase electric motors.
- If the differential of current load exceeds 10% between the legs, or the balanced load current of all three legs has increased over 10% since the most recent measurements, order a replacement motor.
- Record readings in the semi-annual log.
- Grease all electrical motors on the blowers with a high-temperature grease, rated for at least 160 degree Fahrenheit.



WEAR ITEMS AND REPLACEMENT PARTS

Part Number	Description	Image
20018005	Blower Inlet Silencer, Black	
20018008	Blower Inlet Silencer, Red	
20018006	Blower Inlet Silencer, Blue	
10013134	Hex Screw, Washer ELCO 10 X 1 Self Tap #3PT Pack of 10 (Kit Not Included With Silencer)	



WEAR ITEMS AND REPLACEMENT PARTS

Part Number	Description	Image
20020127	Stargate™ Blower Venturi, Black	
20020129	Stargate™ Blower Venturi, Red	
20020128	Stargate™ Blower Venturi, Blue	

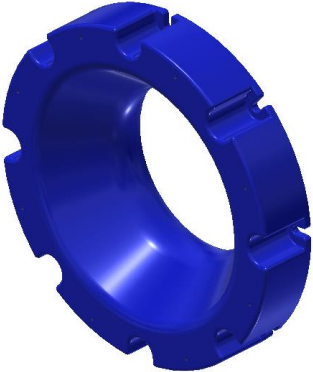
WEAR ITEMS AND REPLACEMENT PARTS

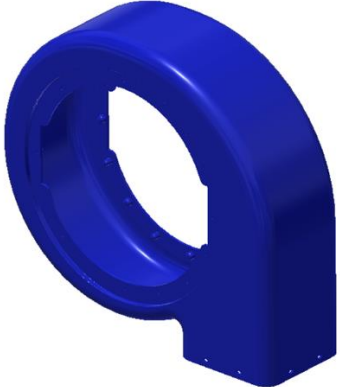

Part Number	Description	Image
10006364	Blower, Plastic Venturi Cone, Black	
10006506	Blower, Plastic Venturi Cone, Red	
10006507	Blower, Plastic Venturi Cone, Blue	

WEAR ITEMS AND REPLACEMENT PARTS

Part Number	Description	Image
20005446	Blower Universal Housing, Black	
20005447	Blower Universal Housing, Red	
20005445	Blower Universal Housing, Blue	



WEAR ITEMS AND REPLACEMENT PARTS

Counterclockwise Impellers

Part Number	Description	Image
10012464	Mammoth 15 HP Blue Impeller	
10008892	15 HP Green Center Impeller	
20003310	10 HP Blue Center Impeller	

WEAR ITEMS AND REPLACEMENT PARTS



Clockwise Impellers

Part Number	Description	Image
10012463	Mammoth 15 HP Grey Impeller	
10008893	15 HP Red Center Impeller	
20003311	10 HP Black Center Impeller	



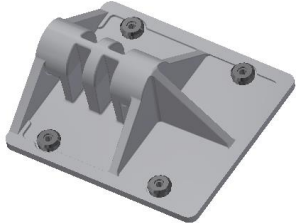

WEAR ITEMS AND REPLACEMENT PARTS

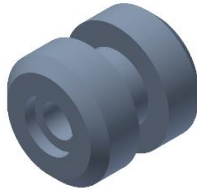
Part Number	Description	Image
10009216	Baldor Motor 10 HP 3490 RPM 215TC Washdown	
10008881	Baldor Motor 10 HP 3490 RPM CEM3711T 215TC 3Ph	
40011965	Elektrim Blower Motor 15 HP 3600 RPM 3Ph	
40012951	Baldor Blower Motor 15 HP 3600 RPM 3PL	



WEAR ITEMS AND REPLACEMENT PARTS

Part Number	Description	Image
20000131	Blower, Motor Mount Plate Assembly	
20005444	Blower, U-Bolt 8-7/8" Assembly	
10007866	U-Bolt 1/2"-13 x 3-1/8" x 8-7/8" Zc	
10002706	Blower, Vibration Isolator Motor Mount Elastomer	

WEAR ITEMS AND REPLACEMENT PARTS

Part Number	Description	Image
20015835	Mammoth Dryer, 1-Side Nozzle Black Kit	
10012662 10013592	Mammoth, Black Trunk 12" Set of 16 Mammoth, Black Trunk 18" Set of 16	
10012664 10013594	Mammoth, Red Trunk 12" Set of 16 Mammoth, Red Trunk 18" Set of 16	
10012663 10013593	Mammoth, Blue Trunk 12" Set of 16 Mammoth, Blue Trunk 18" Set of 16	
10012665 10013595	Mammoth, Green Trunk 12" Set of 16 Mammoth, Green Trunk 18" Set of 16	

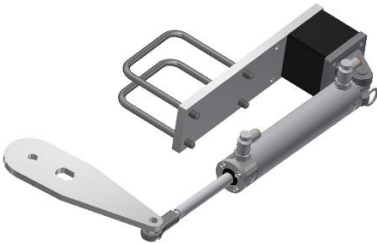
WEAR ITEMS AND REPLACEMENT PARTS

Part Number	Description	Image
20016082	Fixed Mammoth Dryer, Mounting Bracket	
10012561	Fixed Mammoth Dryer, Bolt Kit, One Side Only	N/A
20016428	Mammoth Pivoting Cylinder Mounting Kit and Hardware	
20016429	Mammoth Pivoting Bracket Driver Side Mounting Kit	
20016430	Mammoth Pivoting Bracket Passenger Side Mounting Kit	

WEAR ITEMS AND REPLACEMENT PARTS

Part Number	Description	Image
10013085	Blower, Single V-Nozzle Black	
10013087	Blower, Single V-Nozzle Red	
10013086	Blower, Single V-Nozzle Blue	
10013524	Blower, Half V-Nozzle DS Black	
10013526	Blower, Half V-Nozzle DS Red	
10013525	Blower, Half V-Nozzle DS Blue	
10013527	Blower, Half V-Nozzle PS Black	
10013529	Blower, Half V-Nozzle PS Red	
10013528	Blower, Half V-Nozzle PS Blue	
10013088	Blower, Double V-Nozzle Black	
10013090	Blower, Double V-Nozzle Red	
10013089	Blower, Double V-Nozzle Blue	
20018832	Blower, Flip V-Nozzle Black	
20018834	Blower, Flip V-Nozzle Red	
20018833	Blower, Flip V-Nozzle Blue	
10002227	Bolt Kit for V-Nozzles Note: Double V-Nozzle Requires 2 Kits	Each Kits Contains: 8 Bolts, 16 Washers and 8 Nuts

Sonny's CarWash College™

Master Your Trade

Comprehensive training to plan, manage, maintain, and grow your business!
Sonnys-Support@SonnysDirect.com / Training@SonnysDirect.com



Hands-On Training – www.SonnysDirect.com/class_schedule

- State-of-the-art equipment labs and collaborative learning environments located in Tamarac, FL & Phoenix, AZ. Hands-on experience that's transferable to your wash.



Real Certifications

- Real training with real testing and certification ensures your staff will gain the necessary skills to make a positive impact that drives savings.



Real CarWash Experts

- Our Instructors have washed over 100 million cars and combined have owned, operated, or managed over 200 car wash locations.



Comprehensive Training Materials

- Participants leave with complete documentation of every procedure, technique, and skill they learn— a lifetime worth of car washing experience.



Tech Support
800-327-8723



Online Classes
877-321-2451

Car Wash College.Digital Chalk.com

Register OR Login
SONNY'S
Support@DigitalChalk.com

CUSTOMER SERVICE & TECHNICAL SUPPORT

Need more help?



For questions regarding **installation, operational issues, settings, or servicing of this equipment** please contact **Sonny's Tech Support** or email at Sonnys-Support@SonnysDirect.com.

To order **replacement parts**, contact **Customer Service**, email us at CustomerService@SonnysDirect.com or visit us on the web at www.SonnysDirect.com.

Toll Free Main Line	800-327-8723	Office: Monday – Friday 8:00 AM – 5:30 PM ET
Fax Number	800-495-4049	
Local Number	954-720-4100	
Customer Service	Option 3	Customer Service: Monday – Friday 8 AM – 8 PM ET
Parts	Option 3	
Equipment Sales	Option 4	
Technical Support	Option 5	

SONNY'S ENTERPRISES INC.
5870 N Hiatus Road
TAMARAC, FLORIDA 33321

Thank you for being a Sonny's car wash equipment owner!

From all of us here at



HOW CAN WE HELP YOU?



Get answers to the most frequently asked questions regarding car wash equipment, improving your operations, attracting customers, investing in a car wash, managing risk at your car wash, instructional videos, and much, much more.

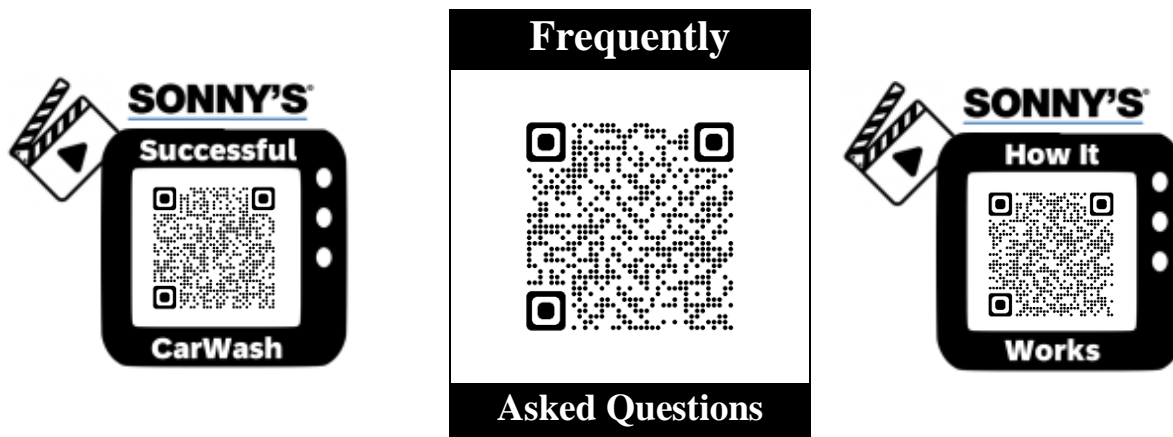

WARRANTY

 **Always Check Latest Warranty Online: SonnysDirect.com (Support Tab)**

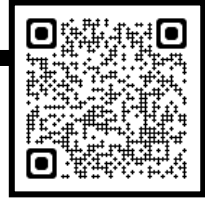

SONNY'S ENTERPRISES, LLC FACTORY LIMITED LIFETIME WARRANTY

Equipment manufactured by SONNY'S ENTERPRISES, LLC is warranted to be free from defect in material and workmanship. Welded metal framework and other non-moving, non-wearable fabricated metal components manufactured by SONNY'S are warranted for the life of the equipment to the original purchaser. Fabricated metal wearable surface and moving components manufactured by SONNY'S are warranted for a period of one (1) year to the original purchaser of the equipment. All components assembled to SONNY'S equipment that are manufactured by others will also be warranted by Sonnys for a period of one (1) year.

Exclusions: The following items are excluded from the 1 year warranty: Brushes on tire brush & tire shiners, all cloth and materials including neoglide, microclean, standard cloth, drying material, and Ecofi; chain, roller and all wear items. Other restrictions may apply. All new cloth shipped with new SONNY'S equipment is warranted for a period of one (1) year or 80,000, whichever occurs first. Microclean is warranted for a period of one (1) year or 60,000 carwashes, whichever occurs first.

Wear items include, but are not limited to, shocks, cylinders, bearings, material, brushes, and any other item that requires regular greasing. Lack of required maintenance will result in denial of warranty. Wear items will be covered in the event of failure upon startup.

Blower motors not installed utilizing split bolt connectors will NOT be warranted. Neither labor nor transportation charges are included in this warranty.



This warranty is not assignable or transferable. The warranty period begins the first day following installation or 30 days from the original invoice date, whichever occurs first. The Seller's liability shall be limited to repair or replacement of materials found to be defective within the warranty period. In the event of repair or replacement this limited warranty is noncumulative. The Purchaser must supply the Seller with immediate written notice when any defects are found. The Seller shall have the option of requiring the return of defective material to establish the Purchaser's claim.

This warranty is based upon the Purchaser's reasonable care and maintenance of the warranted equipment. It does not apply to any equipment which has been subject to misuse, including neglect, accident or exposure to harsh chemicals or chemicals that react violently with water, organic acids (e.g. acetic acid), inorganic acids (e.g. hydrofluoric acid), oxidizing agents (e.g. peroxides), and metals (e.g. aluminum). Chemicals corrosive to aluminum alloys, carbon steel, and other metals. Nor does it apply to any equipment which has been installed, repaired or altered by anyone not so authorized by SONNY'S. Further, the equipment must be properly installed with proper accuracy of all specified plumbing, electrical, and mechanical requirements. This warranty does not apply to normal wear and tear or routine maintenance components.

EXCEPT AS EXPRESSLY STATED HEREIN, SONNY'S SHALL NOT BE LIABLE FOR DAMAGES OF ANY KIND IN CONNECTION WITH THE PURCHASE, MAINTENANCE, OR USE OF THIS EQUIPMENT INCLUDING LOSS OF PROFITS AND ALL CLAIMS FOR CONSEQUENTIAL DAMAGES. THE LIMITED WARRANTY EXPRESSED HEREIN IS IN LIEU OF ALL OTHER WARRANTIES EXPRESSED OR IMPLIED. SONNY'S NEITHER ASSUMES NOR AUTHORIZES ANY PERSON TO ASSUME FOR IT ANY OTHER OBLIGATION OR LIABILITY IN CONNECTION HEREWITH.

ONLINE PRODUCT MANUALS & TECH BULLETINS



Scan QR Code Product Manuals	Scan QR Code Technical Bulletins
	
Backroom Support Equipment	Central Vacuums
Central Vacuum Systems and Components	Friction Washing Components
Chemical Applicators and Components	Pre-Wash
Controls	Control Release Notes
Conveyors and Components	
Drying Components	Architectural Bulletins
Electronic Components	
Friction Wash	Safety Bulletins
High Pressure Systems	
Pre-Wash	
Signage	

FREE NEWSLETTERS AND ALERTS

JOIN THE FAMILY
SIGN UP to get exclusive content.



Select the Publication You Need to Support the Growth of Your Business

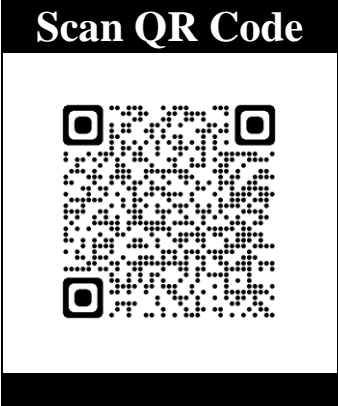

- Tunnel Equipment:** Latest tips to get more customers, reduce operating expenses, and improve customer satisfaction.
- Parts & Supplies:** Get Special Offers on car wash parts and supplies. Industry leading delivery times and the largest inventory in the world!
- Maintenance & Repair:** Receive CarWash College's latest tips to run a more profitable wash.
- Technology, Controls, & Point-of-Sale:** Learn the latest tips and tricks to leverage technology to increase profits and reduce costs.
- Car Wash Marketing:** Ideas to capture, upsell and retain your unfair share of customers both onsite and online. Marketing and signage tips to increase membership and average tickets, decrease churn and improve loyalty.
- Car Wash Chemistry:** Information to help you deliver a clean, dry, and shiny car every time at a cost that makes sense.
- Detailing:** Deals on everything you need to run your professional, and express detailing center.
- Do's & Don'ts:** Tips and Tweaks to keep your Sonny's Equipment at peak performance.
- Water Treatment:** Tactics to optimize every drop of water to reduce utility costs and elevate the cleaning process.

FREE CAR WASH CATALOGS & BOOKS



EMERGENCY CONTACTS

Scan QR Code

Emergency
CarWash Equipment
Tunnel Equipment
CarWash Parts & Supplies
CarWash Controls
CarWash College
CarWash Chemistry
CarWash Signage
Corporate
New Investors

UNLIMITED WASH CLUB

Details

Join Us

With your **OneWash™** membership, you'll have unlimited access to the industry's only complete suite of car wash business solutions with benefits.



Join Sonny's
OneWash ✓
and Save

- | | | | |
|--|---|--|--|
| | <p>Consulting
Expert guidance to help you go from breaking ground to ground-breaking performance.</p> | | <p>College
Comprehensive hands-on training to plan, manage, maintain and grow your business.</p> |
| | <p>Equipment
Trusted leadership from the world's largest manufacturer of conveyerized car wash equipment.</p> | | <p>Services
Local installation, service and support to build and operate your business.</p> |
| | <p>Vacuums
The industry's best-selling central vacuum with professional grade durability to maximize uptime.</p> | | <p>Controls
Complete business management technology to deliver efficiency and profitability across your locations.</p> |
| | <p>Marketing
Marketing consultation, design and campaign management to attract, upsell and retain customers onsite and online.</p> | | <p>Signage
Custom branded signage and lighting to create a value proposition and on-site experience that dominates.</p> |
| | <p>Chemistry
The most convenient and accurate way to deliver a clean, dry and shiny car.</p> | | <p>Backroom
Integrated backroom systems designed to consistently achieve superior performance.</p> |
| | <p>Water
Revolutionary treatment to elevate water quality and reduce waste.</p> | | <p>Parts
12,000 parts in stock for immediate delivery to support your business with inventory for every OEM.</p> |

Learn More at:
www.SonnysDirect.com/onewash

BOOST YOUR SALES

with **SLAM**



WHAT YOU SEE IS WHAT YOU GET

Sonny's CarWash
Signage
by **Mr. Foamer**™

INCREASE YOUR TICKET

Custom branded signage and lighting to create a value position and onsite experience that dominates.

The advertisement features a dark background with a car wash structure. At the bottom, a red pickup truck is shown with a large, colorful sign on its roof that says "MONSTER GUARD" and features a cartoon monster character.



CONTROL YOUR PROFITABILITY



Sonny's Point-of-Sale & Back-Office Management System

Engineered with state-of-the-art technologies and designed exclusively for the car wash industry with input from experienced real-world operators. This high-performance car wash point-of-sale (POS) computer system comes complete with features designed to help you maximize your site's profitability, including cash flow management, employee scheduling, VIP club membership programs, house / fleet accounts, online shopping, E-Commerce, and more!

Increase Uptime, Revenue, and Customer Loyalty While Reducing Operating Costs.

SECURITY AT YOUR FINGERTIPS



Compliant Car Wash Video Security Systems

Eyeson Digital Surveillance & Management Systems provides your car wash end-to-end real-time surveillance and monitoring of the entire perimeter of your property including the tunnel, building access points, vacuum stations and employee work areas.

Each system is custom-designed specifically for your car wash security needs and available 24/7/365 live monitoring gives you peace of mind from false damage and accident claims, or cash loss resulting from theft or shrinkage.

Eyeson delivers more, much more. Imagine being able to search by license plate to find all footage of a car on your property or identifying an intruder on your property at 2am looking to steal copper being questioned by a live person via a 2-way speaker that can send the police. These are the options available that let you focus on what really matters—growing your business!

GROW YOUR BUSINESS



Why Choose Car Wash Buildings' Pre-Manufactured Car Wash?

Car Wash Buildings' complete package is designed to provide you with a world-class express exterior car wash structure that dazzles your customers and eclipses your competition without the high cost and lead times associated with traditional building construction.

Unique Light Wall

Forget the signs that drivers are mentally trained to ignore, now you can turn your entire building into a 24/7 marketing tool that draws in passing traffic. The light wall is visible through the glass walls and can be programmed for different color schemes to match your branding, or even seasonal advertising. Imagine turning your car wash green and red for Christmas, or red, white and blue for the 4th of July – even pink in October for breast cancer awareness month!

Your entire order should be available within **8-12 weeks** after you give us authorization to begin production.



Designed here. Built here. Backed here.™

Interested
Scan QR Code

TOTAL SOLUTION

 <p>Consulting</p>  <p>Invest With Confidence</p>	 <p>College</p>  <p>Master Your Trade</p>	 <p>Equipment</p>  <p>Wash More Cars</p>
 <p>Controls</p>  <p>Drive Business Forward</p>	 <p>Backroom</p>  <p>Unlock Operational Efficiency</p>	 <p>Chemistry</p>  <p>Make Cars Shine</p>
 <p>Water</p>  <p>Optimize Every Drop</p>	 <p>Vacuums</p>  <p>Maximize Customer Experience</p>	 <p>Marketing</p>  <p>Win Every Customer</p>
 <p>Signage</p>  <p>Increase Your Ticket</p>	 <p>Services</p>  <p>Leverage Local Support</p>	 <p>Parts</p>  <p>Keep On Washing</p>



Designed here. Built here. Backed here.™



Make CarWashing Easy™

