

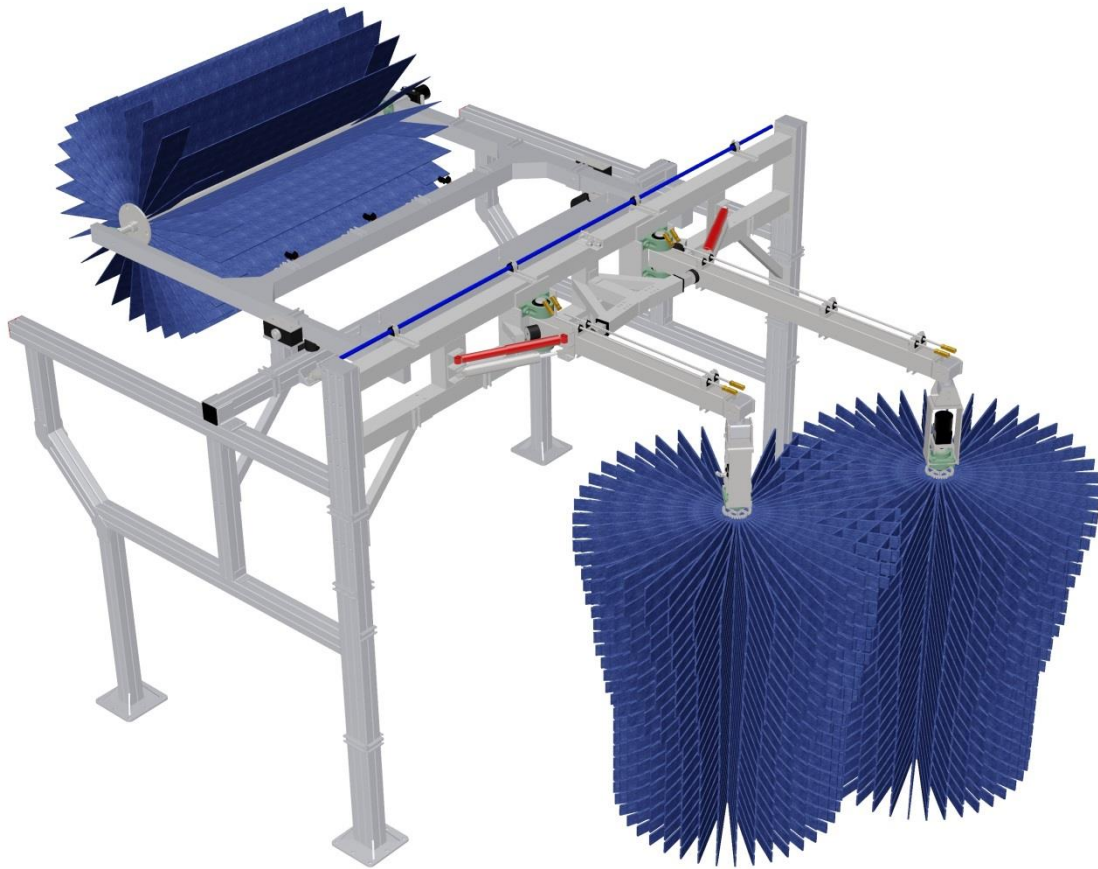

Top Brush Electric & Hydraulic



Owner's Manual

Sonny's Enterprises, Inc.
5605 Hiatus Road
Tamarac, Florida 33321
16v1



Table of Contents

WARNING *SAFETY REQUIREMENTS* WARNING	3
INTRODUCTION	5
Product Specifications	6
Optional Related Equipment	7
INSTALLATION	9
Utilities Requirements	9
Dimensions	10
Equipment Installation	13
Top Brush Installation	13
Brush Hub Installation	15
Electric “Flender” Motor	17
Electric “WindSmith” Motor with Gearbox	18
Hydraulic Motor	19
Adjustments and Testing	20
GENERAL OPERATION	21
PREVENTIVE MAINTENANCE	22
PARTS LIST	23
WARRANTY	25
CUSTOMER SERVICE	26



WARNING *SAFETY REQUIREMENTS* WARNING

1. All employees must be thoroughly trained in safe operation and standard maintenance practices. All employees must review this entire manual monthly.
2. Do not enter the wash tunnel when the equipment is operating. Death or dismemberment may occur.
3. Do not wear loose fitting clothing or jewelry around moving equipment. Do not allow any part of your body or other objects (including ladders, hoses or tools) to come in contact with moving equipment. Entanglement may result causing death or dismemberment.
4. Do not leave a ladder or any other items such as wash down hoses or tools in the wash tunnel while equipment is running. Vehicle damage and injury, including death, can occur.
5. Always exercise caution when walking (never run) through the wash tunnel as there may be slippery conditions. Be careful so you do not bump into or trip over equipment.
6. Only those employees specifically instructed and trained by the location management are permitted to enter the wash tunnel to perform inspections or maintenance. At least two qualified maintenance people must be present when performing equipment repairs or preventive maintenance.
7. Do not perform any maintenance or work on equipment unless you first perform Lock-Out Safety Precautions. All electrically powered equipment must have manually operated disconnects capable of being locked in the "OFF" position. Equipment that has been "locked out" for any reason must be restarted only by the person who performed the "lock out" operation.
8. When working on any equipment that is higher than your shoulders, always use a fiberglass ladder that is in good condition.
9. Do not attempt to repair or adjust any pressurized liquid or pneumatic part, hose, pipe or fitting while that equipment is in operation.
10. Electrical connections and repairs must be performed by a Licensed Electrician Only.
11. Emergency "STOP" buttons must be well marked and their location and proper use reviewed with all personnel. Any activated "STOP" button must be reset only by the person who activated it. Clear the wash tunnel of any people, ladders, hoses, tools and other loose items before restarting the equipment. An audible device must sound to warn people that the equipment is starting.
12. Do not operate any piece of equipment that requires safety covers with those covers removed or improperly installed. Do not operate any piece of equipment if any component of that piece is suspected to be defective or malfunctioning.



Program - Manuals Top Brush / TOP Series Electric & Hydraulic

13. Store all cleaning and washing solutions and oils in a well-ventilated area. Clean up fluid spills immediately to prevent hazardous safety conditions. Be certain to follow all safety procedures on SDS Sheets for each chemical product used.
14. All hydraulic and electric systems in the wash tunnel equipped with a torque relief or overload should be checked and set at the minimum amount that will allow for proper functionality under normal washing conditions.
15. No unauthorized people should ever be permitted in the wash tunnel or near the equipment at any time.

* * *

!! CAUTION !!

When a piece of equipment must be in operation during inspection or maintenance, one qualified technician must stay at the power disconnect switch while another qualified technician performs the inspection or maintenance.



INTRODUCTION

This Owner's Manual contains information that is vital to the successful installation, operation and maintenance of your SONNY'S vehicle washing equipment.

Please read, and understand, the full contents of this manual before installation and operation of the equipment. Keep this booklet in a location where it may be used for ongoing reference.

Should you have any questions on the operation or servicing of this equipment please contact

TECHNICAL SERVICES DEPT.

SONNY'S ENTERPRISES INC.

5605 Hiatus Road

TAMARAC, FLORIDA 33321

TELEPHONE: 800-327-8723 FAX: 800-495-4049





Product Specifications

- Designed to occupy 120" of tunnel length and 144" width
- 4" x 4" aluminum frame and legs for stability and durability
- Pivot bearing is solid UHMW and with a grease fitting to increase smoothness of operation
- Double Roller bearings on shaft
- Hydraulic brush drive motors use 6GPM @ 800PSI
- Pivot shaft constructed of 1½" stainless steel
- Hub that doesn't absorb water with NEOGLIDE
- Optional Whisper Brush to reduce noise
- Chemical delivery system sold separately
- Brush tracks the contour of the vehicle using only a counterweight
- 1/2 inch city water connection

Optional Related Equipment

SONNY'S Hush Series Top Brush



Problem You need to remove heavy dirt or bugs from vehicle top surfaces and eliminate windshield "eyebrow" in a limited tunnel distance.

Solved SONNY'S Hush Brush features a simple proven design with a unique counterweight balancing system that applies equal wash penetration on all horizontal surfaces. Neither the included NEOGLIDE foam wash material nor hub absorbs water which allows the pressure to remain constant regardless of volume. The new Hush Brush reduces interior noise without sacrificing wash quality, brush longevity, or safety.

ELECTRIC
HYDRAULIC



Features

- Gentle Hush Brush with NEOGLIDE foam material
- Operator-friendly stainless steel counterweight adjustments
- Cleans contoured hoods and eliminates windshield "eyebrows"
- Perfect balance
- Sturdy frame & standard components for easy maintenance
- Durable QuadX Aluminum frame construction
- Optional Foundation Frame provides ability to mount additional wash components



Protect & beautify your equipment with optional powder coating. Call for pricing.



New Hush Brush with genuine NEOGLIDE foam material is quieter than ever before!



Counterweight delivers perfect balance and equal wash pressure.



Hush Brush with NEOGLIDE foam wash material is gentle, quiet, and does not retain water.



Included detergent application system.

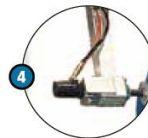

Available with electric or hydraulic motor.



Program - Manuals Top Brush / TOP Series Electric & Hydraulic

Ordering Information

SONNY'S NeoGlide Hush Brush

	Item #	Description	Price
Choose Your Motor	Hydraulic	Top Brush, Frame Hydraulic No Brush	\$9,965.00
	Electric	Top Brush, Frame Flender Elect No Brush	11,258.00
Choose Your Legs for Required Foundation Frame Attachments		Top Brush Legs Set	2,500.00
		Top Brush Legs Set With Tire Attachment	3,500.00
		Top Brush Legs Combo Reverse Wrap	3,500.00
		Top Brush Legs Combo Exit Wrap	3,500.00
		Top Brush, Legs Combo Rev Wrap W/TireAtt	4,200.00
		Top Brush Legs Cmbo Exit Wrap W/Tire Att	4,200.00
Add Our Exclusive Hush Brush		Top Brush, Tunnel Hush Brush Black	2,364.00
		Top Brush, Tunnel Hush Brush Blue	2,364.00
		Top Brush, Tunnel Hush Brush Red	2,364.00
		Top Brush, Tunnel Hush Brush Green	2,364.00
Required Air Kit	20010232	EQ AIR KIT 24V CON R/U,TBG RET,O&SP FLIP	124.88
	20010233	EQ AIR KIT 110V CON R/U,TBG RET,O&SP FLP	124.88
Required Chemical Pump Station	20006068	Dosatron, Single 500:1 Non-Foam Panel	1,024.00
Optional Automatic Retract Kit	20005819	Retract Kit, Top Brush Auto	1,792.00

Optional Foundation Frame™ Attachments								
Tire/Poodle Brush	Bison Brush	Ninja Brush	SFTBG18 Rocker Brush	SFB18 Side Washers	SFB21 Side Washers	SFB28 Side Washers	OMNI 50 Wheel Blasters	Wrap-Around Washers
Tire Brushes			SFB Side Washers			OMNI		Wraps
Opt.	Opt.	Opt.	Opt.					
				Opt.	Opt.	Opt.	Opt.	Opt.
				Opt.	Opt.	Opt.	Opt.	Opt.
Opt.	Opt.	Opt.	Opt.					Opt.
Opt.	Opt.	Opt.	Opt.					Opt.

Specifications

	Inches	Metric
Footprint Length	114in	2.89m
Footprint Width	144in	3.65m
Height	143in	3.63m
Vehicle Clearance	90in	2.28m
Water Inlet	3/4in	19mm
RPM		75
Hydraulic		4GPM
Optional Electric		1HP

Popular

Foundation Frame™ Combination

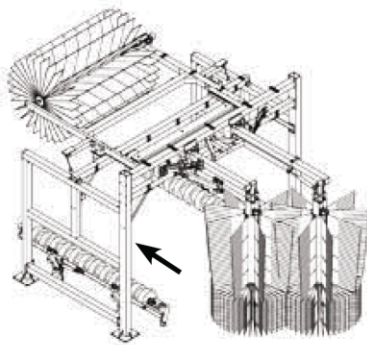

SONNY'S Foundation Frame™ provides the ability to mount additional items to maximize tunnel space and more importantly – lets you easily and affordably increase wash performance as your business grows.

- SONNY'S Top Brush with NeoGlide Hush Brush
- SONNY'S Bison Brush
- SONNY'S SF68RA Wrap-Around Washers
- 24 Volt

Footprint length: 241in

	Item #	Description	Price
Top Brush	20005701	Top Brush, Frame Hydraulic No Brush	\$9,965.00
	20005713	Top Brush Legs Cmbo Exit Wrap W/Tire Att	4,200.00
	20007197	Top Brush, Tunnel Hush Brush Blue	2,364.00
	20010232	EQ AIR KIT 24V CON R/U,TBG RET,O&SP FLIP	124.88
Bison	20006068	Dosatron, Single 500:1 Non-Foam Panel	1,024.00
	20010104	Tire Brush, Brushless Sub Assembly Hyd.	4,238.00
	20003200	Bison Brush Only 96 x 12in 4Bolt Attach (2 Req)	1417.50
	20010234	EQ AIR KIT 24V WRAP, GB, TBG RET & WP	137.03
Wrap-Around Washers	20010234	EQ AIR KIT 24V WRAP, GB, TBG RET & WP	137.03
	20005604	Wrap, Straight Hydraulic Attachment	8,030.00
	20005617	Wrap Brushes 68" Hyd C-Channel Set DS/PS	4,778.00
	20003401	Cloth, SF68 Wraps, Set For 2 Hubs	1,367.04
	20010234	EQ AIR KIT 24V WRAP, GB, TBG RET & WP (2 Req)	274.06
	10006168	Dema, 414P3 Val Sol 1/2in N/C JB24V	52.32
20003124	G57 PS FMR Assy 1 Pump 1 Tank 24V	635.00	
Total Package Price:			\$38,743.86



INSTALLATION

Utilities Requirements

**UTILITIES INTERCONNECTION AND THE MATERIALS REQUIRED FOR INTERCONNECTION TO SONNY'S EQUIPMENT ARE THE RESPONSIBILITY OF THE CUSTOMER !
PERFORM ALL TRADES WORK TO ALL APPLICABLE LOCAL AND NATIONAL CODES !**

Water

- The Customer's Plumber is to provide and install a 1/2 inch city water line @60PSI (nominal) to the solenoid valve on the chemical distribution system for the Washer.

Electrical

- The Customer's Electrician is to provide and install single phase power from the (24 or 110 VAC as determined at time of order) from the Customer's Controller system to the liquid solenoid valve for the brush spray bars and, if required, the motor starter coil for the hydraulic power pack feeding the brush and any pump motor for the chemical distribution system.
- The Customer's Electrician is to provide and install single phase power from the remote push-button station through the tunnel equipment programmer to the supplied air solenoid valve on the Air Distribution Manifold for retract of both washers upon selective signal (see Figure #6 in Dimensions Section).
- The Customer's Electrician is to provide materials and install 208VAC or 230VAC or 460VAC, 3-phase, 60Hz power to the electric motor on the hydraulic power pack or VFD panel from a properly sized three pole circuit breaker and motor starter with three thermal overloads when applicable.

Compressed Air

- The Customer's Plumber is to provide and install a 1/2 inch compressed air line from the Air Compressor to the Air Distribution Manifold for the Retract functions.

Dimensions

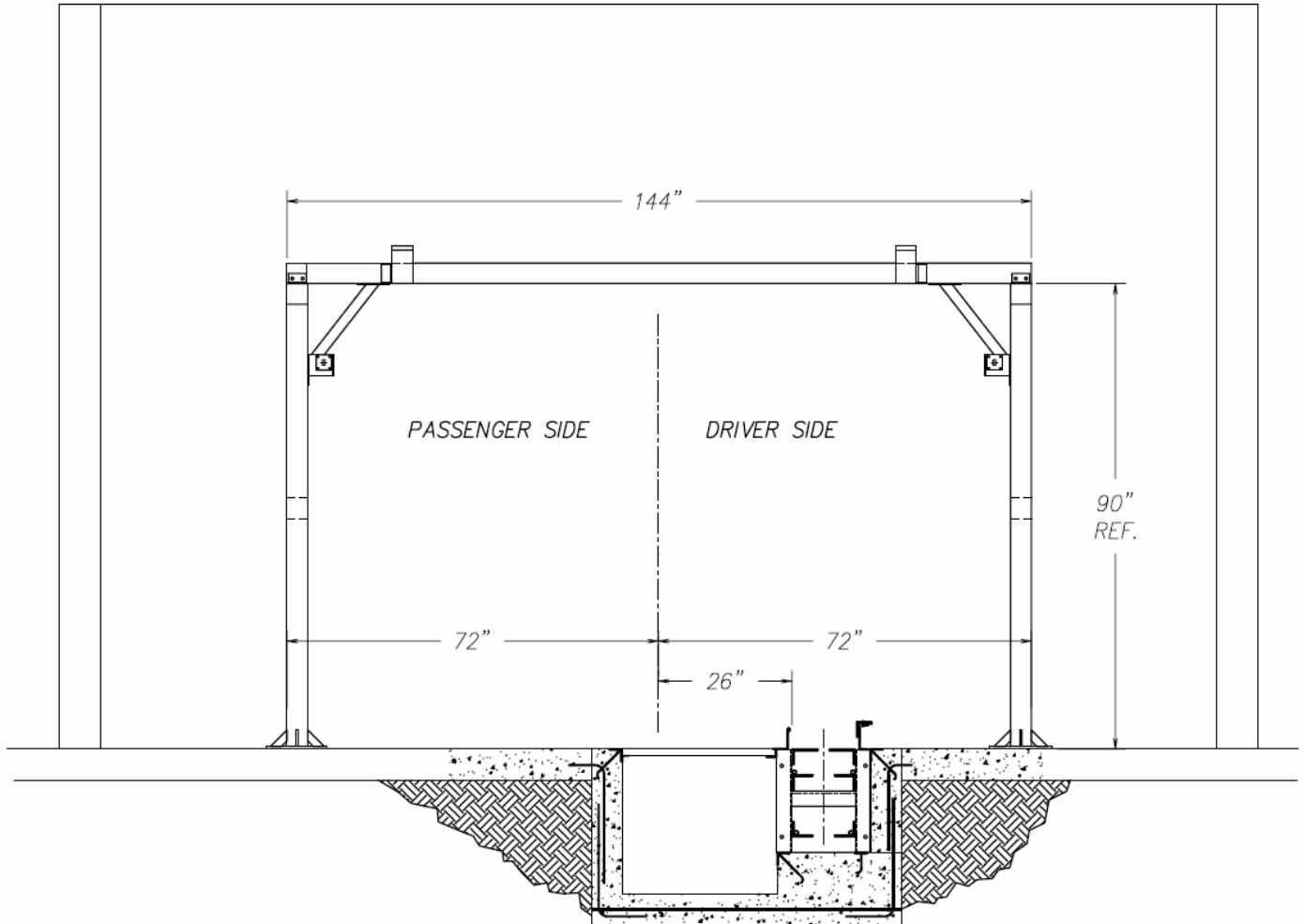

Figure #1

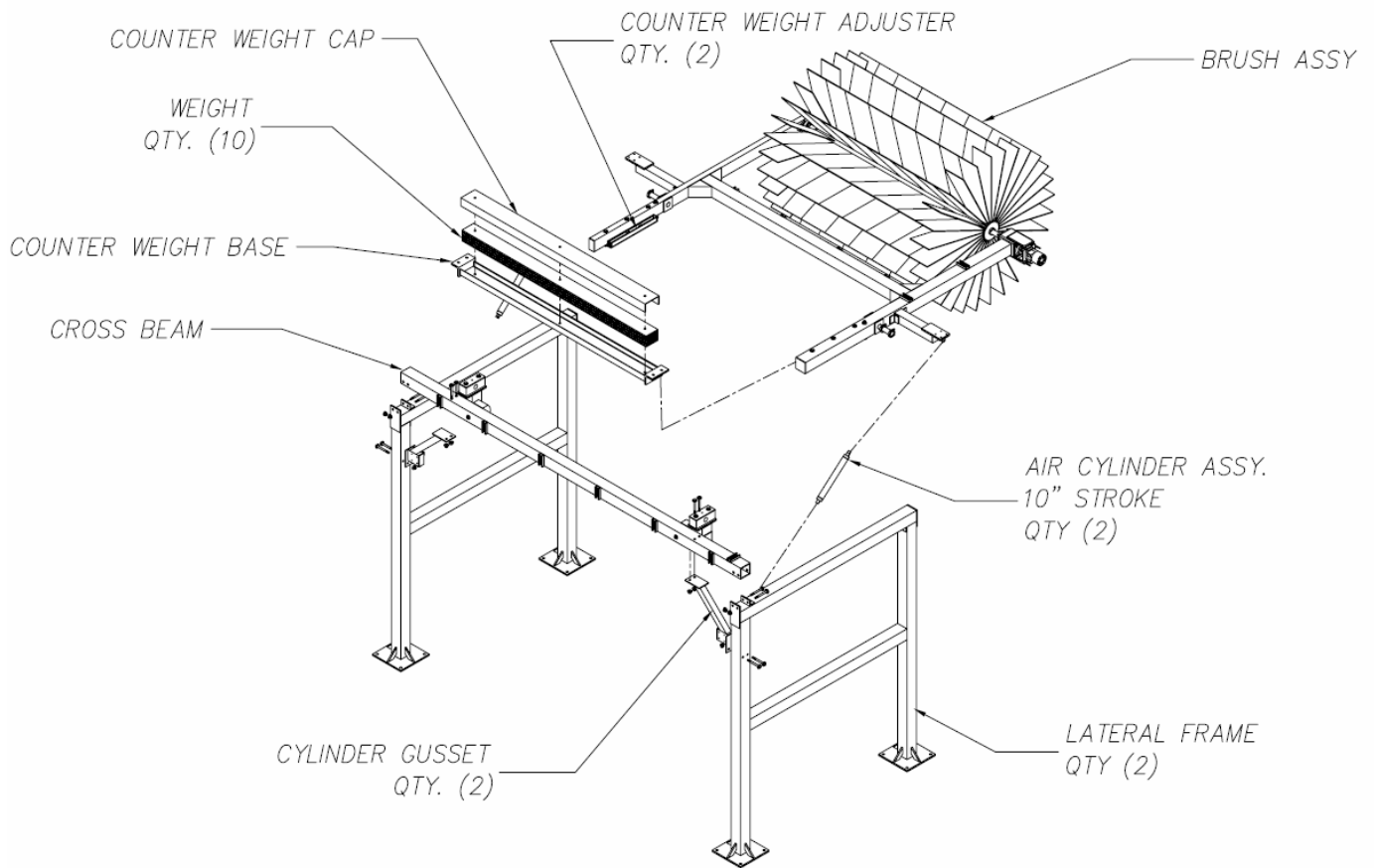

Figure #2

TOP BRUSH PNEUMATIC DIAGRAM
TYPICAL EACH CYLINDER

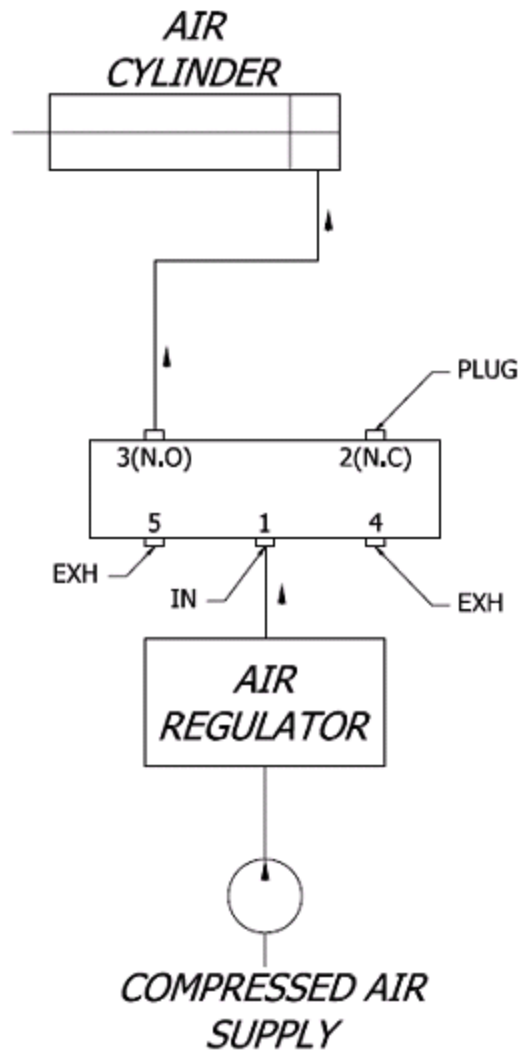

Figure #3



Equipment Installation

Top Brush Installation

Tools

1. Safety Glasses
2. ½ " Drive Ratchet Set
3. Standard Combo Wrenches
4. 4' Level
5. Electric Impact Wrench
6. 1" Hammer Drill
7. Tape Measure
8. Sledge Hammer

Work Force

Two (2) persons

Consumables

1. Anti-Seize Compound
2. Marine Grease

Time (assuming no problems)

2.00 – 4.00 hours

Installation Steps

1. Determine where the Top Brush is to be installed (See Figure #1 in the Dimensions Section and the tunnel layout drawings for your location).
2. Sweep any debris from where the Top Brush will stand.
3. Check all hardware and place a small amount of Anti-Seize Compound on each bolt.
4. Install counterweight assembly on the frame.
5. Place the assembled frame side legs, cross beams and gussets in the area where the unit will be permanently located (with the brush counterweight toward the entrance of the car wash).
6. With the interconnection hardware provided by SONNY'S (boxed and attached to the assembly frame) join the legs, cross beams and gussets to the frame "finger tight".
7. Level and square the frame with the centerline of the equipment (see Figure #1 in the Dimensions Section and the tunnel layout drawings for your location).

Note: Ensure the frame is correctly located before installing any lag bolts. Before lagging the frame into position have a second person double check all measurements against your tunnel equipment layout drawings to ensure all measurements were performed correctly.



Program - Manuals Top Brush / TOP Series Electric & Hydraulic

8. Place an anchor bolt in each corner. Tighten all hardware.
9. Place and anchor the unit per the dimensions shown in Figure #1. Be certain that the entrance and exit cross beams are level (shim mounting feet, if necessary) and that each of the 4 vertical legs are plumb.
10. Install brush and counterweight assembly on the frame.
11. Install the air retract cylinders and run one airline to the valve for the retract operation.

NOTE: Air is used to hold the brush in the retracted position only. No air is used during the wash process.

12. Run and connect the chemical lines from the Chemical Distribution Manifold to the chemical line on the frame for the application nozzles.
13. Run and connect a 1/2 inch PRESSURE line from the Hydraulic Power Pack to the 1/2 inch male pipe thread fitting on the BLACK high pressure hose on the frame.
14. Run and connect the 1/2 inch RETURN line to the Hydraulic Power Pack to the 1/2 inch male pipe thread fitting on the ORANGE/RED high pressure hose on the frame.
15. Rotation of the brushes is against vehicle travel. As viewed from the driver side the brush turns COUNTERCLOCKWISE.
16. Install the brush onto the frame.

Brush Hub Installation

1. Remove and discard the retainer plate from one end of top brush assembly. Insert the screws and lock washers to the DS Spindle.

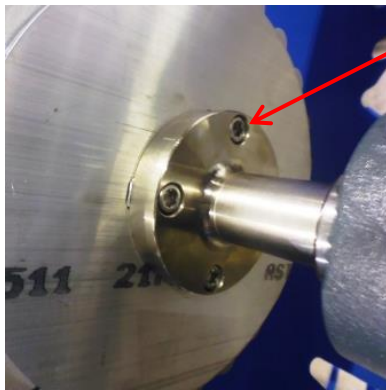

Use Screws



2. Hold the brush straight, insert the end of the brush to the DS top brush arm spindle and Tighten into place with the screws.

3. Remove and discard the retainer plate from the other end of top brush assembly. Insert the screws and lock washers to the PS Spindle.

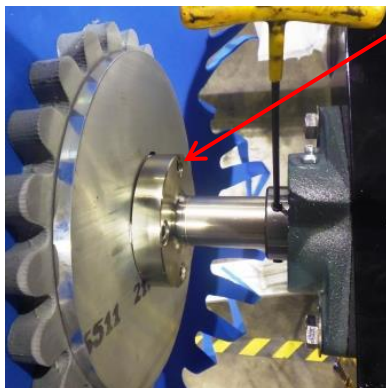

Use Screws

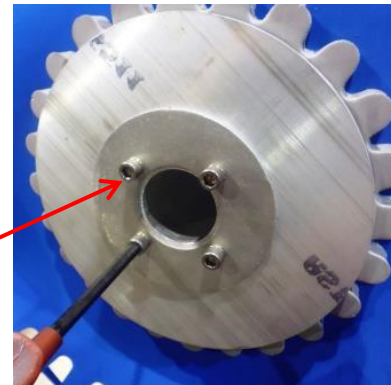

4. Loosen DS bearing set screws to be able to slide the brush.

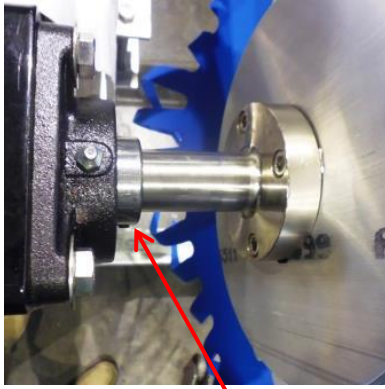

PS Set Screws

5. Slide the brush into the PS spindle and tighten the screws.

DS Set Screws

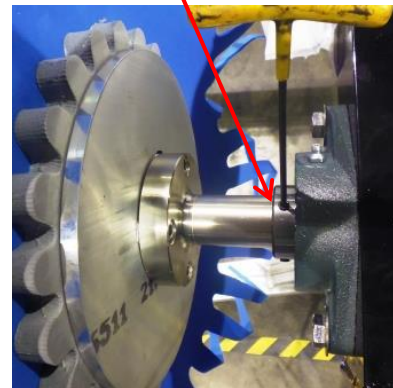

6. Once the top brush assembly is securely tightened to both spindles (DS & PS), go ahead and tighten the DS bearing set screws. Check the PS bearing set screws to make sure they are also tighten.

Electric “Flender” Motor

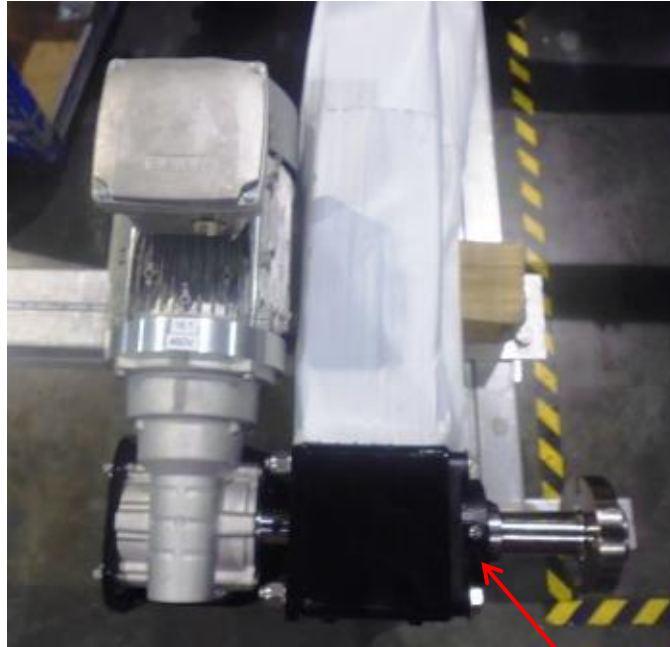

Loosen the DS and PS shaft bearing set screws to adjust the brush to the center of the top brush arms, once centered then tighten the shaft set screws.

Electric “WindSmith” Motor with Gearbox

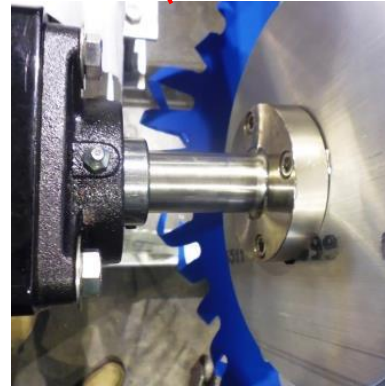
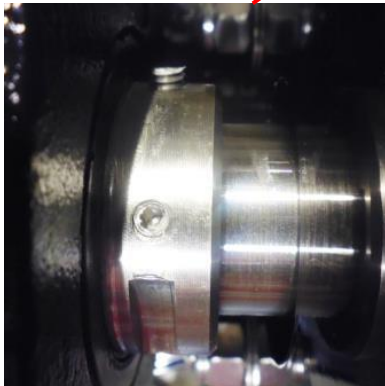

To adjust the brush to the center of the top brush arms, loosen the DS and PS shaft bearing set screws, and then loosen the inner shaft collar set screws.

Once the brush is centered, tighten the inner shaft collar set screws, and then tighten the DS and PS shaft bearing set screws.

Hydraulic Motor

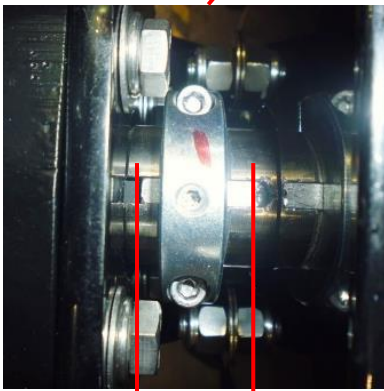
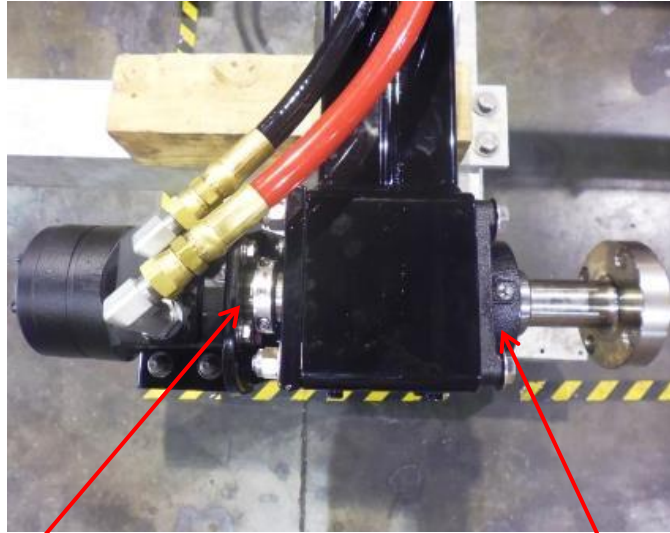

Shaft Key Centered

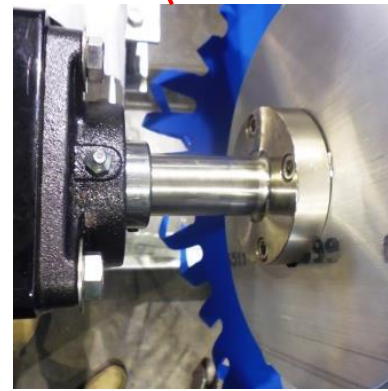

To adjust the brush to the center of the top brush arms, loosen the DS and PS shaft bearing set screws.

Loosen the inner shaft key set screw, and then loosen the collar screws.

Once the brush is centered, verify and center the shaft key to the middle of the collar.

Tighten the inner shaft collar set screws, and then tighten the DS and PS shaft bearing set screws.



Adjustments and Testing

Adjust the Cleaning Pressure of the Washer

Ensure the air solenoid is manually put in the wash position so there is no air pressure applied to the retract cylinder. Adjust the position of the counterweight so that when the counterweight is released the brush slowly moves downward. After initial adjustment manually activate and deactivate the air retract. When deactivated the brush should fall smoothly to the down position. Final adjustment of the counterweight can be accomplished while running test vehicles. Once adjusted properly the cloth penetration should be about three to four inches across the entire vehicle. If brush bounces too much the counterweight has been adjusted to far out. Adjustment is easiest if made in small amounts, approximately 1/4" to 1/2" at a time.

Adjust the Rotation Speed of the Brush

The brush speed can be adjusted at the flow control valve on the hydraulic power pack. It should be between 85 and 95RPM with conveyor speeds of 100 to 150CPH. If the conveyor speed is reduced to between 60 and 90CPH the brush speed should also be reduced to approximately 75 to 85RPM.

Adjust for Smooth Retract Operation

To adjust the retract operation the air pressure regulator should be adjusted for approximately 30PSI in the retract position. The tunnel controller should be adjusted so that the brush is put into the wash position prior to the front of the car arriving at the brush. This will entail deactivating the retracts before the vehicle reaches the brush and setting the look ahead to check for the proximity of the next car.

Speed and Torque Adjustment (where applicable)

1. Hydraulic
 - a. The speed can be adjusted on the flow control for the power pack.
 - b. To increase the speed move the handle on the flow control closer to the number 10.
 - c. To decrease the speed move the handle on the flow control closer to the number 1.
 - d. The torque must be set prior to operation and should be set between 600 and 900 PSI. For information on how to set the torque please refer to the Hydraulic Power Pack Manual.
2. Electric
 - a. The speed can be adjusted on the Variable Frequency Drive (VFD).
 - b. To increase the speed adjust the Hertz on the VFD to a higher number.
 - c. To decrease the speed adjust the Hertz on the VFD to a lower number.
 - d. The Overload on the Motor Starter protector(s) must be set at the lowest level to allow for operation. Adjust the amps in accordance with motor(s) name plate.



GENERAL OPERATION

Top Brush Operation

Brush rotation starts and stops with a signal from the Customer supplied Controller system to the Customer's hydraulic power pack which drives the hydraulic motors on the brushes. This Controller Start-Stop signal should also control soap solution delivery to the spray bar on the brush.

BE CERTAIN THAT THE BRUSHES ROTATE AGAINST VEHICLE TRAVEL

With the brush rotating (against the direction of vehicle travel and at proper RPM) the vehicle's front hood contacts the brush and brush travels across the vehicle maintaining steady contact while cleaning the hood, roof and trunk of the vehicle.

Proper cloth penetration on flat vehicle surfaces should be 3 to 4 inches. As the brush rounds corners, such as on windshields, the cloth penetration may be greater, but not deeper than half the distance to the aluminum brush core.

Retract Operation

When there is no vehicle approaching the brush the tunnel controller will retract the brush from the wash position, toward the ceiling. This can also be set up in the controller to retract for the beds of trucks to avoid problems.

It is recommended that the brush be retracted for:

1. Sun visors mounted over the windshield.
2. Any racks mounted on the roof.
3. Rear wipers on Acura Integra's and Mazda RX-7's unless they are taped down.
4. Open bed pickup trucks.



PREVENTIVE MAINTENANCE

DAILY

1. Check all hydraulic, air and chemical lines and fittings for leaks. Repair, or replace, as needed.
2. Check brush for proper operation, listening for any unusual noises from the equipment.
3. Inspect brush cloth for cuts, grease, or oil. Remove and repair, or replace, any cloth panel if any of these conditions are found.
4. Check retract and extend for proper operation, smoothness and correct application pressure.
5. Check for proper chemical solution delivery.

WEEKLY

1. Spray lubricant on the clevis pins on both ends of the retract cylinders.
2. Grease the brush shaft bearings. Do not allow grease to come in contact with brush cloth.
3. Drain water from FRL and check lubricant level in FRL.

FOR THE FIRST MONTH OF OPERATION CHECK ALL HARDWARE AND FITTINGS FOR TIGHTNESS EACH WEEK. PERFORM THIS INSPECTION TO THE SCHEDULE SHOWN BELOW AFTER THE FIRST MONTH OF OPERATION.

MONTHLY

1. Inspecting all hardware and fittings for tightness.
2. Grease the UHMW pivot bearings. Do not allow grease to come in contact with brush cloth.
3. Inspect the bumper stops for wear to ensure the air cylinders have not reached the end of their travel. If bumper stops are worn they can be flipped to extend life.
4. Inspect soap solution spray nozzles for wear. Replace as necessary.
5. Thoroughly clean the equipment and framework.

SEMI-ANNUALLY

1. Carefully inspect brush equipment cloth for wear and damage. Replace as necessary.
2. If fluid in reservoirs is contaminated drain, purge, and refill.

PARTS LIST

Hydraulic Motor for Top Brush



- Torqmotor TE Series
- SAE O-Ring ports



Item #	Description	Price
10008079	Parker Hyd Motor TE0195FS100AAC MF1209	\$323.24
10001775	Elbow, 45deg 1/2 M JIC X 5/8 M O-Ring	2.85
10006558	Woodruff Key Half Moon 1 1/8in HS14118	0.98
10003765	37C125HCSSZ Hex Bolt 3/8-16 x 1 1/4 Zc	0.14
10001487	37NLOC0Z Washer 3/8in Split Lock Stl Zc	0.02

Hydraulic Shaft & Split Collar



Item #	Description	Price
20010311	Shaft, Top Brush 1 1/2in x 93.5in	\$139.55
10003530	Collar, 2pc Clamp 1 3/8in w/Set Screw Zc	10.49

Torque Channel



Item #	Description	Price
20007255	Torque Channel w/Plastic Knobs	\$84.12

Top Brush Cloth Hub & Spider Assembly

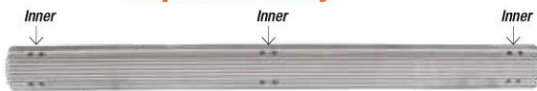

Item #	Description	Price
20010441	Hub, 68in x 6in for Top Brush 28 Slots	\$319.99
20002067	Spider, Kit 6in x 3in Wide Top Brush	42.25

4-Bolt Bearing for Top Brush



Item #	Description	Need	"E"	Price
10005077	Bearing, 4Bolt Flange 1 1/2in AMI	2	4 1/8in	\$27.05
10008267	50C825HCSS Hex Bolt 1/2-13 x 8 1/4 SS	4	-	20.40
10002957	50NWUSS Washer 1/2in Flat USS Zc	8	-	0.15
10004704	50CNNS Hex Nut Nylon 1/2-13 SS	4	-	0.56

2-Bolt Bearing for Top Brush

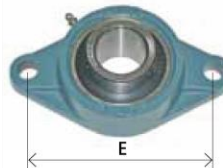

Item #	Description	Need	"E"	Price
10005005	Bearing, 2 Bolt Flange 1 1/2in AMI	2	5 21/32in	\$25.71
10006922	50C350HCSS Hex Bolt 1/2-13 x 3 1/2 SS	2	-	2.48
10002957	50NWUSS Washer 1/2in Flat USS Zc	4	-	0.15
10004704	50CNNS Hex Nut Nylon 1/2-13 SS	2	-	0.56

Nozzle Components



Item #	Description	Price
10002241	Hypro 402275N Check Val 8lb 1/4 MPTxQuic	\$3.60
10003533	Nozzle, Air Foaming Size 04 110deg	11.58

6in Hub Disk & Split Collar



Item #	Description	Need	Price
20001174	Cloth Stop, UHMW Top Brush	2	\$10.30
10003173	Collar, 1pc Split 1 1/2in Zinc Plated	2	6.75

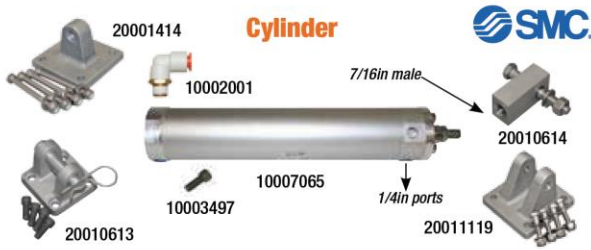

Cylinder



Item #	Description	Price
10007065	Cylinder, A11210-2 2in Bore x 10in Stk	\$108.12
20001414	Rear Eye Mount, 1/2in Top Brush w/Bolts	20.99
20010613	Rear Clevis, 1/2in x 2in w/Hardware	26.29
10002001	Elbow, Swivel 3/8in Tube x 1/4in MPT	3.05
20010614	Rod Eye, 3/8in x 2 1/2in Bolt & Nut	23.09
10003497	Screw, Soc Cap 1/4-28 x 5/8 Stl	0.11
20011119	Rear Clevis Mount Cast 3/8" x 2 1/4" Kit	CALL

Pivot Shaft, Collar, Plastic Bearing & Plate



Item #	Description	Price
20004605	Shaft, Top Brush Pivot SS 1 1/2in x 8in (Driver Side)	\$34.30
20002021	Shaft, Top Brush Pivot SS 1 1/2in x 10in (Passenger Side)	40.18
10003420	Collar, 2pc Clamp 1 1/2in Zinc Plated	9.89
20001948	UHMW, Bearing 1.5in Bore x 8in Top Brush	56.78
20001561	Cover Plate, Top Brush 8in x 3in SS	29.00

Counter Balance Adjuster & Weight Bar



Item #	Description	Price
20002742	Adjuster, Counter Balance Weldment	\$247.52
20004593	Weight, Counter Balance 1/2in x 5in x 77	63.98

Rubber Bumper Stops



Item #	Description	Price
10010220	Rubber Bumper Heavy Duty Top Brush	\$11.64
10003431	SF77RS Rubber Stop 3inDia x 2.25in Lgth	26.25

Winsmith Gearbox & Sterling Motor for Electric Top Brush



Item #	Description	Use with	Price
10008538	Gearbox, Winsmith 20:1 Ratio	Neoglide	\$528.00
10008539	Gearbox, Winsmith 25:1 Ratio	Cloth	528.00
10008069	Sterling Motor 1.5HP 1800RPM 56C 230/460	-	297.00
10009566	Gearbox, Gasket C-Face 920 Series	-	20.48

E5 Couplers for Electric Top Brush



Item #	Description	NEED	Price
10007136	E5 Coupler, Element Only	1	\$110.66
10006866	E5 Coupler, Half 1 3/8in Bore Hub	2	89.03
10002706	Vibration Isolator	4	6.20

Brush & Winsmith Gearbox Shafts for Electric Top Brush

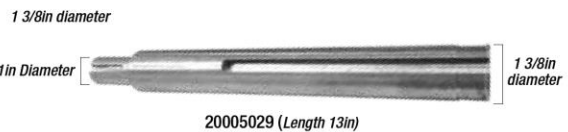

Item #	Description	Price
20004598	Shaft, Top Brush Elect Winsmith 94.5in L	\$93.38
20004603	Shaft, Top Brush Elect Winsmith 8in L	49.46
20005029	Top Brush, Winsmith Adapter Shaft	42.99



WARRANTY

SONNY'S ENTERPRISES, INC. FACTORY LIMITED LIFETIME WARRANTY

Equipment manufactured by SONNY'S ENTERPRISES, INC. is warranted to be free from defect in material and workmanship. Welded metal framework and other non-moving, non-wearable fabricated metal components manufactured by SONNY'S are warranted for the life of the equipment to the original purchaser. Fabricated metal wearable surface and moving components manufactured by SONNY'S are warranted for a period of one (1) year to the original purchaser of the equipment.

All components assembled to SONNY'S equipment that are manufactured by others are warranted by the appropriate manufacturer and subject to that manufacturer's limited warranty. Contact SONNY'S for the specific information on other component manufacturer's warranty terms. All new cloth shipped with new SONNY'S equipment is warranted for a period of one (1) year or 80,000, whichever occurs first.

This warranty is not assignable or transferable. The warranty period begins the first day following installation or 30 days from the original invoice date, whichever occurs first. The Seller's liability shall be limited to repair or replacement of materials found to be defective within the warranty period. In the event of repair or replacement this limited warranty is noncumulative. The Purchaser must supply the Seller with immediate written notice when any defects are found. The Seller shall have the option of requiring the return of defective material to establish the Purchaser's claim. Neither labor nor transportation charges are included in this warranty. Transportation damage claims are to be submitted to the carrier of the damaged materials.

This warranty is based upon the Purchaser's reasonable care and maintenance of the warranted equipment. It does not apply to any equipment which has been subject to misuse, including neglect, accident or exposure to harsh chemicals or chemicals that react violently with: water, organic acids (e.g. acetic acid), inorganic acids (e.g. hydrofluoric acid), oxidizing agents (e.g. peroxides), and metals (e.g. aluminum). Chemicals corrosive to: aluminum alloys, carbon steel, and other metals. Nor does it apply to any equipment which has been repaired or altered by anyone not so authorized by SONNY'S. Further, the equipment must be properly installed with proper accuracy of all specified plumbing, electrical, and mechanical requirements. This warranty does not apply to normal wear and tear or routine maintenance components.

EXCEPT AS EXPRESSLY STATED HEREIN, SONNY'S SHALL NOT BE LIABLE FOR DAMAGES OF ANY KIND IN CONNECTION WITH THE PURCHASE, MAINTENANCE, OR USE OF THIS EQUIPMENT INCLUDING LOSS OF PROFITS AND ALL CLAIMS FOR CONSEQUENTIAL DAMAGES. THE LIMITED WARRANTY EXPRESSED HEREIN IS IN LIEU OF ALL OTHER WARRANTIES EXPRESSED OR IMPLIED. SONNY'S NEITHER ASSUMES NOR AUTHORIZES ANY PERSON TO ASSUME FOR IT ANY OTHER OBLIGATION OR LIABILITY IN CONNECTION HEREWITH.



**Program - Manuals
Top Brush / TOP Series
Electric & Hydraulic**

CUSTOMER SERVICE

Please contact SONNY'S Equipment Department for installation and/or operational questions regarding this piece of equipment.

Please refer to the Parts Catalog and contact SONNY'S Customer Service Order Entry Department for any replacement parts for this piece of equipment.

You can also visit the web at www.SonnysDirect.com.

DEPARTMENT

Toll Free Main Line
Equipment Department

PHONE NUMBERS

800-327-8723
954-720-4100

FAX NUMBERS

800-495-4049
954-720-9292

Or you can email Sales at sales@SonnysDirect.com

Thank you for being a SONNY'S car wash equipment owner!

From all of us here at

